

TRAIL

IMPLEMENTATION

PLAN



THE CITY OF

RANCHO CUCAMONGA

CALIFORNIA

ACKNOWLEDGEMENTS

The following individuals have contributed their time, energy, knowledge and valuable insight to the Trail Implementation Plan:

City Council

Dennis L. Stout, Mayor
William J. Alexander, Mayor Pro Tem
Pamela J. Wright
Charles J. Buquet II
Diane Williams
Jack Lam, AICP, City Manager

Planning Commission

Larry T. McNeil, Chairman
Suzanne Chitica, Vice Chairman
John Melcher
Wendy Vallette
Peter Tolstoy
Brad Buller, City Planner

Trails Advisory Committee

Suzanne Chitica
Pamela Henry
Mark Whitehead
Peter Tolstoy
Greg Pilcher
Paul Senft

Participating City Staff

Dan Coleman, Principal Planner; Project Manager
Anna-Lisa Hernandez, Planning Aide; Word Processing
Randy Day, Planning Aide; Computer

Special appreciation is due to the following Alta Loma Riding Club Trails Committee members for their commitment to trail issues and foresight in preparing the original proposal for a riding and hiking trails element for the City's General Plan which became the inspiration for the Trail Implementation Plan:

Pamela Henry
Christine Benoit
Claudia Hall
William Henry
Eunice Hall
Rosalind Winters

In addition, appreciation is due to the many residents of Rancho Cucamonga and interested persons who have participated in the trail planning and implementation process.

RESOLUTION NO. 91-262

A RESOLUTION OF THE CITY COUNCIL OF THE CITY OF RANCHO CUCAMONGA, CALIFORNIA, APPROVING THE TRAILS IMPLEMENTATION PLAN

WHEREAS, the City's General Plan established a Master Plan of Trails for a network of hiking, biking, and horse riding trails as a recreational element; and

WHEREAS, the City's General Plan policies call for programs to improve existing trails to make the trails safer, more functional, and accessible and to facilitate development of Regional Multi-Purpose Trail and Community Trails systems; and

WHEREAS, the Trails Implementation Plan is consistent with the goals and policies of the City's General Plan regarding trails; and

WHEREAS, the Trails Advisory Committee has reviewed and recommended approval of the Trails Implementation Plan; and

WHEREAS, the Planning Commission has recommended to the City Council approval of the Trails Implementation Plan.

SECTION 1: The City Council of the City of Rancho Cucamonga does hereby resolve as follows:

1. The City of Rancho Cucamonga has an investment in the trails system of over \$10.3 million as evidenced by over 100 miles of existing Regional, Community and Local Feeder Trails; and
2. The trail system is designed as a multi-purpose system that benefits many users, including, pedestrians, hikers, riders, and bicyclists; and
3. The trails system, particularly the bicycle trail system, provides an important means of non-motorized transportation which reduces traffic, noise, and pollution; and
4. The implementation strategy contained in the Trails Implementation Plan represents a long-term plan that will be accomplished over many generations to come; and
5. The trail system should be implemented, whenever possible, through the planning review process as development occurs.

SECTION 2: Be it further resolved by the City Council of the City of Rancho Cucamonga that their policy is to use grants or other trail funding sources, rather than new assessments or impact fees.

SECTION 3: Be it further resolved that the Trails Implementation Plan is hereby approved.

PASSED, APPROVED, and ADOPTED this 16th day of October, 1991.

AYES: Alexander, Buquet, Stout, Williams, Wright

NOES: None

ABSENT: None

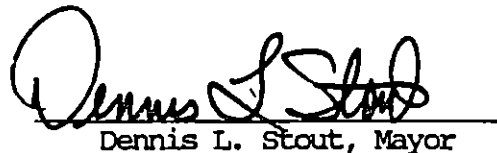

Dennis L. Stout, Mayor

ATTEST:

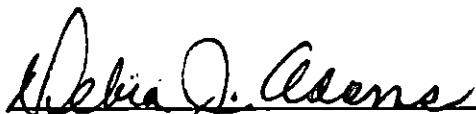
Debra J. Adams, City Clerk

I, DEBRA J. ADAMS, CITY CLERK of the City of Rancho Cucamonga, California, do hereby certify that the foregoing Resolution was duly passed, approved, and adopted by the City Council of the City of Rancho Cucamonga, California, at a regular meeting of said City Council held on the 16th day of October, 1991.

Executed this 17th day of October, 1991 at Rancho Cucamonga, California.



Debra J. Adams, City Clerk

TABLE OF CONTENTS

Chapter 1:	Introduction	Page
1.1	Purpose	1
1.2	Benefits of a Trail System	1
1.3	The 1981 General Plan Trails Element	2
1.4	Relationship to Other Regulations	2
Chapter 2:	Setting	
2.1	Location	3
2.2	Existing Trail System	4
2.3	Physical Characteristics	4
2.4	Population Characteristics	5
2.5	Recreation Characteristics	5
Chapter 3:	Hiking and Riding Trails Concept	
3.1	Overview	6
3.2	Primary Loop Trails	7
3.3	Community Trails	9
3.4	Local Feeder Trails	11
3.5	Trail Heads	11
3.6	Equestrian Facilities	11
3.7	Exercise Stations	12
3.8	Crossings	12
Chapter 4:	Bicycle Trails Concept	
4.1	Overview	14
4.2	Trip Types	14
4.3	Physical Constraints to Bicycle Use	15
4.4	Bicycle Trail Policies	16
4.5	Bicycle Trail System	16
Chapter 5:	Sphere of Influence	18
Chapter 6:	Design Standards	
6.1	Trail Width	19
6.2	Hiking and Riding Trails	20
6.3	Bicycle Trails	22
6.4	Design Standards for Class I Bike Paths	22
6.5	Design Standards for Class II and Class III Bike Trails	25
6.6	Trail Signing	26
Chapter 7:	Administration	
7.1	Responsibility	30
7.2	Trail Alignment	31
7.3	Acquisition	31
7.4	Design	31

	Page
7.5 Plan Check Coordination	31
7.6 Construction and Inspection	32
7.7 Maintenance	32
7.8 Enforcement	33
7.9 Trail Abandonment	34
Chapter 8: Implementation	
8.1 Regulatory Procedures	35
8.2 Sources of Funding	35
8.3 Acquisition of Trails	37
8.4 Phasing of Trail Improvements	39
8.5 Community Hiking & Riding Trail Improvement Projects	39
8.6 Regional Hiking & Riding Trail Improvement Projects	40
8.7 Bicycle Trail Improvement Projects	41
Appendix	43
9.1 Preliminary Construction Estimates	
9.2 Financing Plan	
9.3 Trail Standard Drawings	
9.4 Ordinance - Trail Maintenance Standards	
9.5 Ordinances - Bicycle Storage Facilities	
9.6 Trails Coordinator Job Description	

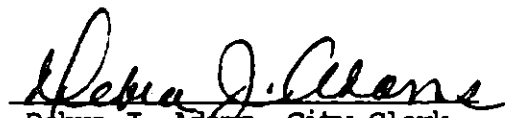
INTRODUCTION

1



INTRODUCTION

"Opportunities exist within Rancho Cucamonga for the provision of trails for transportation and recreation usage. Horseback riding, hiking, jogging, running, walking and bicycling can all be accommodated in some way within Rancho Cucamonga.

One of the secondary benefits of the many flood control channels lacing through the City is the availability of right-of-way for trail purpose. These rights-of-way were once part of the San Bernardino County Recreational Plan, providing for multi-usage; i.e. bicycles, hiking and equestrian.

In northern Alta Loma residential development has provided for equestrian use. However, there were no consistent design standards employed resulting in inadequate trail systems, and a fragmented collection of easements within various tract developments; the majority of which lack standard trail widths, uniform design, and development. Many trails empty into the street or deadend at walls, fences, ravines, or flood control channels.

The Trails Plan deals with two areas; the resolution of existing trail problem areas within developed residential areas; and a consistent policy for a new trail system for new development where appropriate."

- General Plan, p. III-61, 62

1.1 PURPOSE

This Trails Implementation Plan is a statement of the City's long-term commitment to completing a trail system. The Plan serves to identify trail policies affecting the entire community and to insure implementation of a trail system in a manner consistent with the Rancho Cucamonga General Plan. It is intended to provide specific implementation strategies from initial planning through construction and maintenance. Completion of the entire trail system may take decades, and this document is intended to guide present and future generations in this effort.

The purpose of the Trails Implementation Plan is :

- To research and analyze existing trail conditions, problems and opportunities.
- To develop a strategy to alleviate trail deficiencies and problems.
- To develop preliminary cost estimates for future trail acquisition, construction, and rehabilitation.
- To identify funding mechanisms for trail acquisition, development, rehabilitation, and maintenance.
- To define the future role of various City departments in the implementation of a trail system.

The Trails Implementation Plan should not be viewed as the final statement of the City's vision. With time, its population will change, its goals will be redefined, and the physical environment in which residents work and recreate will be altered. The Plan represents a summary of the City's hope for the future to establish a trail system. In this sense, the Trails Implementation Plan should be considered a "living document" that may be periodically revised to respond to and reflect changing conditions.

1.2 BENEFITS OF A TRAIL SYSTEM

The development of public parks and recreational facilities was identified as one of the most important needs in the community by the citizens who participated in developing the City's first General Plan. The implementation of a trails system provides significant direct and indirect benefits to Rancho Cucamonga as a whole, and to trail

user groups in particular. Recreation is one of the basic necessities of life, maintains the general welfare of the public and enhances the quality of life in the community.

The City has identified eight benefits to the entire community through the trail system :

1. Provides a means of non-vehicular circulation which reduces pollution, noise, and traffic.
2. Makes the community more livable, increases property value and contributes to a "higher quality of life."
3. Benefits individuals and employers by improving health and reducing health care costs.
4. Conserves land, open space, energy, and natural resources.
5. Contributes to civic pride and social unity.
6. Provides experiences that promote skills development, self-confidence, social interaction, a balanced life style and education about our natural environment.
7. Provides access to public lands and serves as a means for people to experience natural settings.
8. Creates a local facility for recreational pursuits.

1.3 THE 1981 GENERAL PLAN TRAILS ELEMENT

Historically, the City's only long range trail planning document has been the Trails Element of the General Plan adopted in 1981. Essentially it is a policy plan created to establish an interconnected trail system for Rancho Cucamonga. Included in the General Plan's *Master Plan of Trails* is a basic concept for regional, community, and local feeder trail routes (see Figure III-7). The regional trail system was based primarily upon a San Bernardino County Parks Department plan for "Sub-Major Trails."

The 1981 General Plan is still the basic policy guide for trails within Rancho Cucamonga. This Trails Implementation Plan will supplement the 1981 General Plan with detailed trail alignments, development standards and funding mechanisms necessary to make the trail system a reality.

1.4 RELATIONSHIP TO OTHER REGULATIONS

The Trail Implementation Plan will provide the user with most of the information needed to determine what City policies, standards, and regulations will guide the development of trails within Rancho Cucamonga. No provision of this plan is intended to repeal or supercede trail policies or standards as may be established by any other specific plan, community plan, condition of approval or existing City ordinance.

SETTING

2.1 LOCATION

The City of Rancho Cucamonga, situated in the southwest corner of San Bernardino County, is 37 miles east of downtown Los Angeles and 15 miles west of downtown San Bernardino. The San Gabriel Mountains and the San Bernardino National Forest rise majestically to the north and the communities of Upland, Ontario, and Fontana surround the City on the west, south and east, respectively.

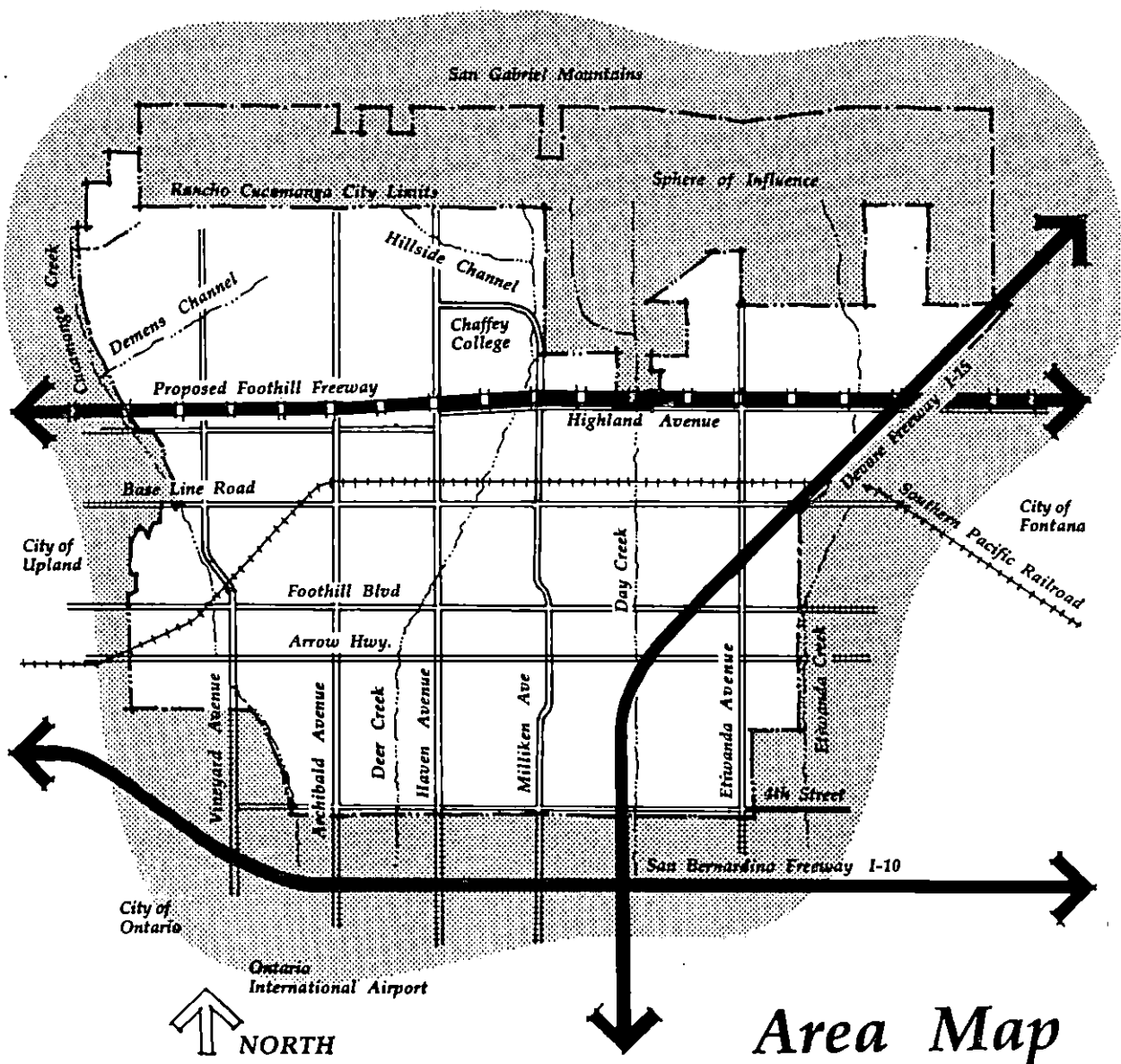

2.2 EXISTING TRAIL SYSTEM

There currently exists, throughout the northern part of the City, a somewhat fragmented collection of equestrian trail easements within tract developments. The majority were established prior to incorporation, with little thought given to circulation pattern and linkages and no consistent trail width or design standards. Maintenance is the responsibility of each property owner, or in a few tracts, of a homeowner's association. There are some sporadic parkway "community" trails along certain arterial, secondary, and collector streets, such as Archibald Avenue.

The City of Rancho Cucamonga currently has a system of over 100 miles of horse riding trails comprised primarily of private local feeder trails within the northern part of the City. These trails are also used by residents for pedestrian activities, such as hiking, jogging, running or walking for pleasure.

Bicycle trails have received less emphasis on development and total approximately 5 miles, not including minor paseo type trails. The majority of the existing bike trails exist along the service roads that parallel the flood control channels or within the master planned communities, such as Victoria and Terra Vista.

A number of dirt roads throughout the area are used as trails, most of which are actually service roads for public utility rights-of-way, such as, flood control, water district, fire service, and power companies. These are particularly noteworthy along the base of, and in, the foothills where the natural scenic value and remoteness are a major attraction. These dirt "trails" attract frequent use by pedestrians, equestrians, and "mountain" bicyclists. Unfortunately, these dirt roads are also used by motorcyclists and off-road vehicles. These dirt roads are on private land and, for the most part, are being used without authorization and often despite signing and barricades.

2.3 PHYSICAL CHARACTERISTICS

Rancho Cucamonga covers approximately 34 square miles including its Sphere of Influence. The City of Rancho Cucamonga is one of the fastest growing cities in the state. Nevertheless, over 10,000 acres of land within the City's limits are still undeveloped primarily east of Haven Avenue.

The City is situated on a gradually sloping alluvial fan near the eastern end of the San Gabriel Mountains. Throughout most of the City, slopes are typically less than ten percent: between the southerly boundary and Base Line Road, they range from 1 to 4 percent; between Base Line Road and Banyan Street, they are 4 to 8 percent; and in the northern portion of the City they are roughly 8 percent and, in limited areas greater than 10 percent. These grades provide for a variety of trail experiences and differing levels of recreational challenges. The terrain immediately north of the City in the foothills becomes much steeper, with slope grades of 20 to 40 percent common.

There is a diverse ecosystem of plant and animal life in Rancho Cucamonga to be experienced from the trail system. The City is located in an area where the species of two distinct environments, desert mountains and coast, intermix. The area was once known for its vineyards and citrus groves, and the Eucalyptus windrows planted to protect them, which are rapidly disappearing as the area develops. Large stands of Eucalyptus windrows still exist in the rural Etiwanda area on the easterly side of the City. The southerly half of the City is characterized by the coastal sage scrub vegetation. Other vegetative communities found in the area include the alluvial association in the northern portion of the City, the hard chaparral association in the northern portion of the foothills and open wash association of the area's canyons, including Angall's, Cucamonga, Deer, Day, Etiwanda, and Thorpe Canyons. Dense stands of large oak, sycamore, toyon, hardtack and native ferns can be explored from the trails which reach into the canyons. Trail users must also exercise caution because of the proliferation of poison oak in the canyons.

**Figure III-7
MASTER PLAN
OF TRAILS**

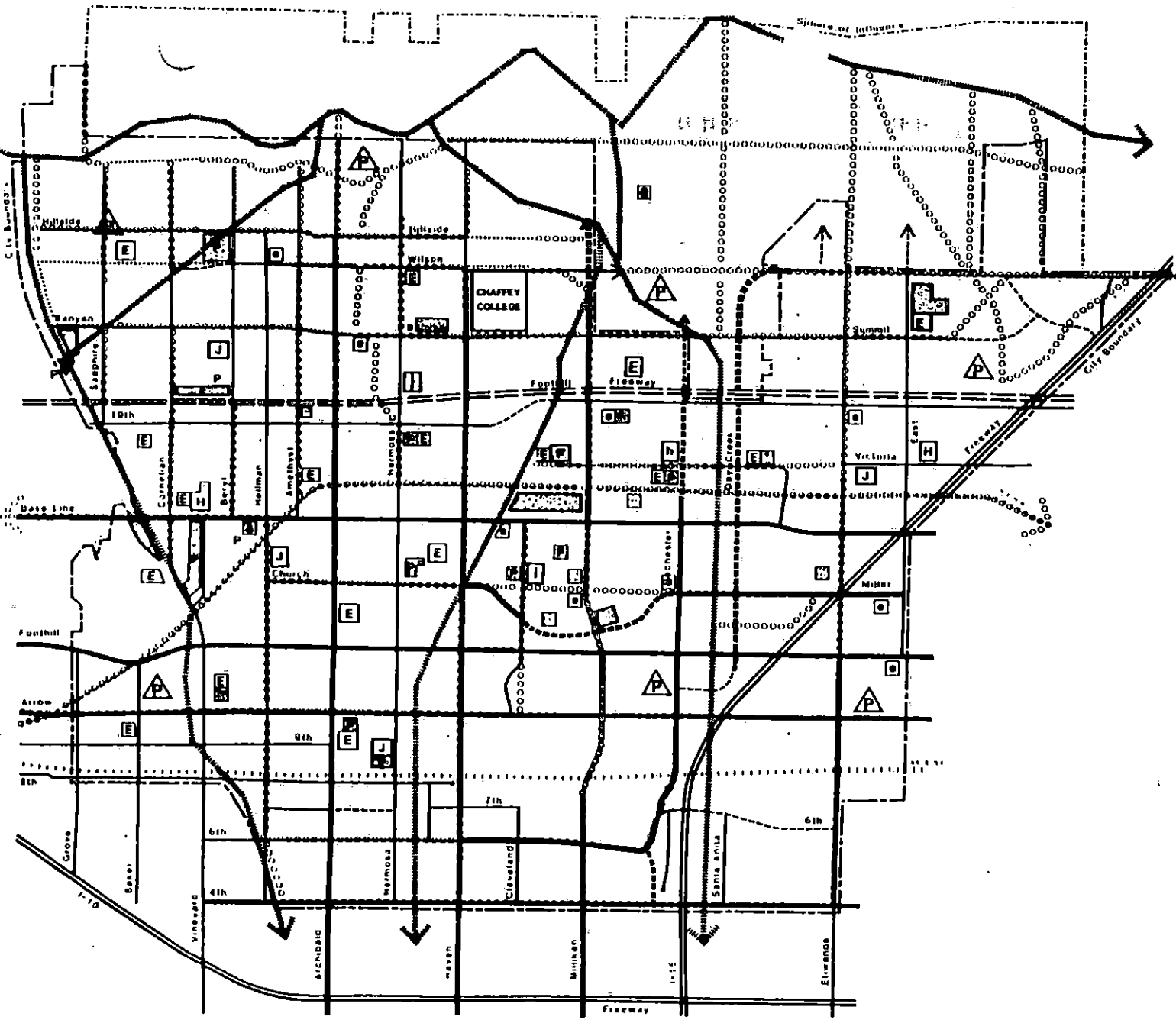

TRAIL SYSTEM
 EXISTING COMMUNITY
 - - - - - PROPOSED COMMUNITY
 ——— REGIONAL MULTI-SYSTEM

PARKS
 [P] PROPOSED PARKS
 [P] EXISTING PARKS
 [P] FLOATING DESIGNATION

SCHOOLS*
 [S] PROPOSED SCHOOLS
 [S] EXISTING SCHOOLS

*PROPOSED SCHOOL SITE LOCATIONS ARE TENTATIVE, BASED UPON INFORMATION PROVIDED BY EACH SCHOOL DISTRICT.

[C] CIVIC/COMMUNITY CENTER
 [R] EQUESTRIAN/RURAL AREA

CITY OF RANCHO CUCAMONGA



SETTING **2**



2.4 POPULATION CHARACTERISTICS

As of January 1989, the estimated population of Rancho Cucamonga was 104,727. The City of Rancho Cucamonga is one of the fastest growing cities in the state, with an annual average growth rate of 11.4 percent since 1985. According to the Southern California Association of Governments growth forecast, approximately 110,000 people will be living in the City by the year 1995 and 127,500 by the year 2000. As the population increases, so too, will the demand for recreational opportunities via trails.

2.5 RECREATION CHARACTERISTICS

The mild Mediterranean style climate makes year round outdoor sports and trail usage possible. The City of Rancho Cucamonga has embarked on an ambitious park development program which will provide logical destination points for trail routes and encourage trail usage. The larger community parks of Heritage, with its extensive equestrian facilities, the play fields at Red Hill, and the multi-facility future 100- acre City Park located at the heart of the community, will be likely hubs for trail activity. The City is also planning a sports complex in the industrial area which will include a minor league baseball stadium and play fields which is also a likely trail destination point.

The City of Rancho Cucamonga is fortunate to be at the center of a number of excellent regional recreational points of interest (See Figure 1). The Angeles National Forest, Mt. Baldy, and Cucamonga-Guasti Regional Park are within a five mile radius. Bonelli, Santa Ana River, Glen Helen, and Prado Regional Parks, and the Chino Hills State Park, all lie within a 17 mile radius of the City.

**Figure 1:
REGIONAL RECREATION
POINTS OF INTEREST**

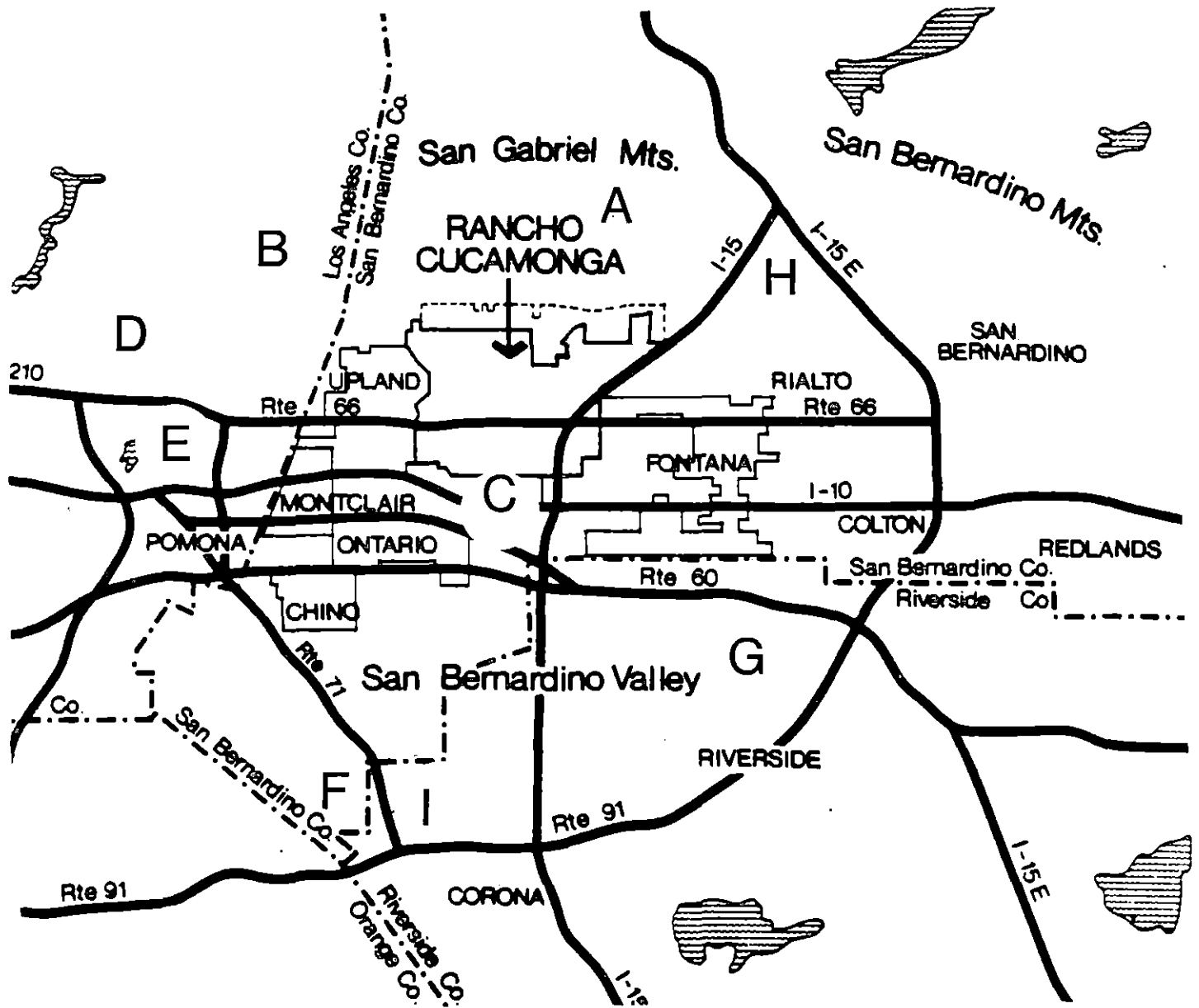

- A San Bernardino National Forest
- B Angeles National Forest
- C Cucamonga-Guasti Regional Park
- D Marshall Canyon Recreational Area
- E Bonelli Regional Park

- F Chino Hills State Park
- G Santa Ana River Regional Park
- H Glen Helen Regional Park
- I Prado Regional Park

**HIKING AND
RIDING TRAILS
CONCEPT**

3



HIKING and RIDING TRAILS CONCEPT

"The objective of the trail system is to delineate an overall network of interconnected trails which are integrated with recreational areas, parks, open spaces, residential, commercial and industrial areas. The overall trail concept is based on three components:

- Regional Multi-Purpose Trails*
- Community Trails*
- Local Feeder Trails*

The Regional Multi-Purpose Trails are the backbone of the system. They are reserved, extended, long distance corridors and serve as the main connectors to the regional parks, scenic canyons, the national forest, other major open spaces, residential, commercial, and industrial areas.

The Community Trails provide the user with access to the Regional Multi-Purpose Trails to community facilities such as Heritage Park, Alta Loma Park, Baseline Park, Elementary, Junior and Senior High Schools, shopping centers and the regional shopping center. Community trails extend through the community along waterways, utility corridors, public rights-of-way, easements and along streets having adequate parking width. Community trails that extend southerly of the shaded area of the Equestrian/Rural Area, should not be required to provide for equestrian usage - except in areas where continuity of the system is needed.

These trails form loops of varying length and act as the initial link of unifying the existing disjointed Local Feeder Trails.

Local Feeder trails, not identified on the map, are contained within subdivisions and enable the user access from their residential lot to neighborhoods, schools, and parks. Emphasis should be placed on establishing appropriate Local Feeder Trails at the time of subdivision approval or development review."

— General Plan, p. III-62

3.1 OVERVIEW





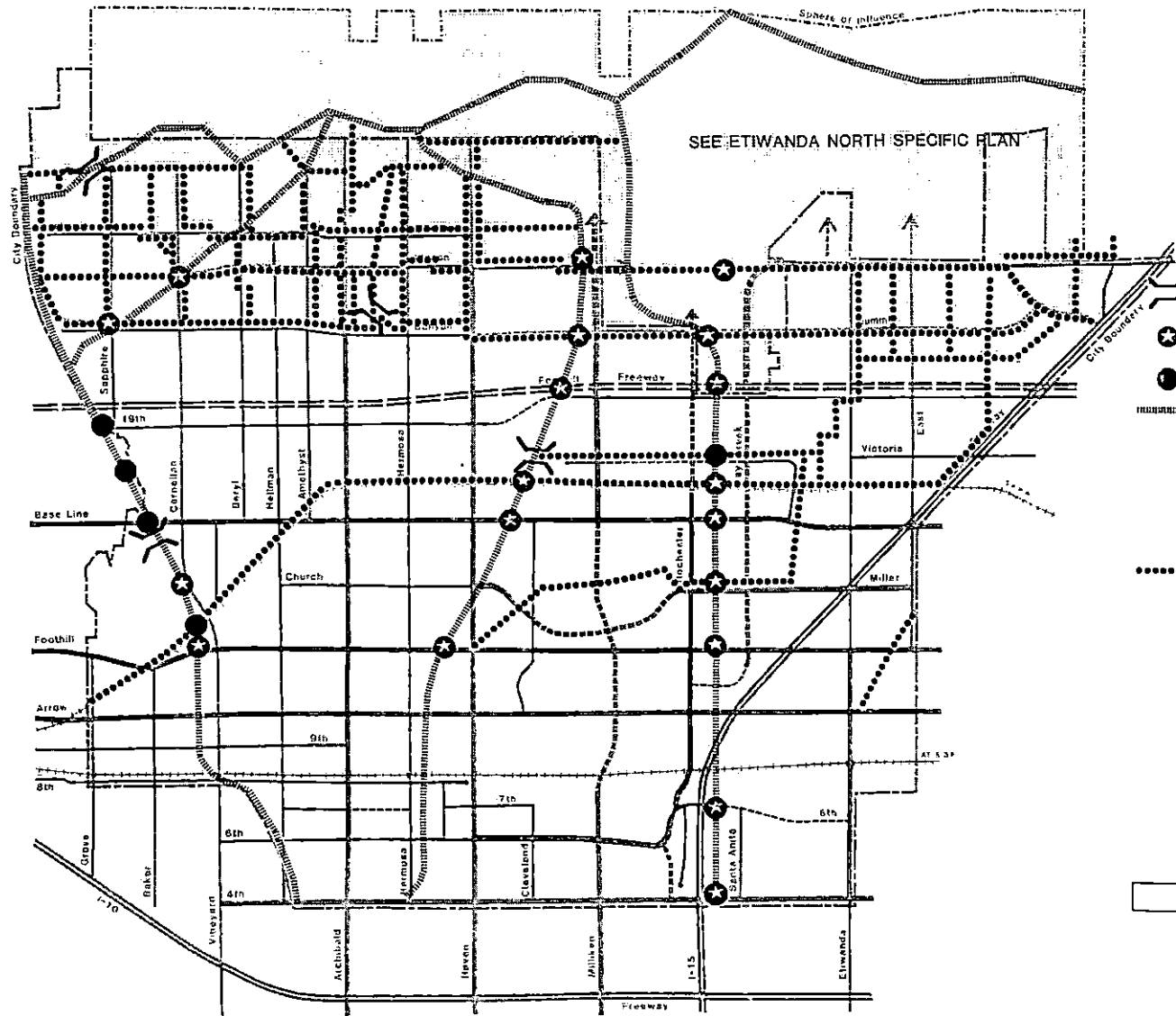

The proposed *Hiking and Riding Trails Master Plan* is shown in Figure 2. Thirty-four miles of Regional Hiking and Riding trails are planned, primarily along existing flood channels. Approximately 63 miles of Community Hiking and Riding Trails are planned, which generally follow street parkways (see Table 1). An accurate count of Local Feeder Trails is difficult to establish because the system is constantly expanding as new tracts are recorded; however, there exists over 100 miles of these trails. For the purposes of this Plan, "hiking" is distinguished from normal pedestrian activities, and is considered to mean vigorous walking or running on unpaved surfaces.

The proposed trail routes were selected as the most advantageous in satisfying the General Plan's *Master Plan of Trails* objectives involving: safety, function, aesthetics, economics and feasibility of acquisition. Preference was given to strategically located existing trailways or dirt roads on public land or easements. The application of development codes for trails in future developments will gradually create trail systems in areas that are currently undeveloped, such as Etiwanda. In a few instances, the City may wish to precede private development or in developed areas lacking vital trail linkages, and actively pursue acquisition of needed trail rights-of-way.

Figure 2: HIKING & RIDING TRAILS MASTER PLAN



LEGEND

-  Proposed Bridge
-  Proposed Street Undercrossing
-  Existing Street Undercrossing
-  Regional Multi-Purpose Trails: The regional trails are the backbone of the public trail system. They are reserved, long distance corridors and serve as the main connectors to the regional parks scenic canyons, the national forest, other major open spaces, residential, commercial, and industrial areas. The regional trails mainly follow flood control channels and utility corridors. They are intended for use as equestrian, pedestrian and bicycle trails.
-  Community Trails: The community trails provide trail user access to community facilities such as parks, schools and shopping centers. These public trails form loops of varying length and act as the link between the local feeder trails in each tract and the regional trails system. Community trails follow streets, utility corridors, and easements. They are intended for equestrian and pedestrian users, except equestrian usage is limited to the Equestrian/Rural Area.
-  Local Feeder Trails (Not Shown): Local feeder trails, not identified on the map, are contained within individual subdivisions in the Equestrian/Rural Area. These trails provide the homeowner with access from the rear of their lot to the community or regional multi-purpose trail system. The local feeder trails are private trail easements which generally follow along the rear property line of residential lots. Although primarily intended for equestrian use, these trails are also frequently used by pedestrians.
-  Equestrian/Rural Area

CITY OF RANCHO CUCAMONGA

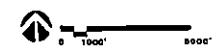

Table 1:
HIKING & RIDING TRAIL SUMMARY

<i>REGIONAL</i>	<i>LENGTH (in miles)</i>
Front Line	10.0
Cucamonga Creek Channel	6.5
Demens Creek Channel	3.0
Hillside Channel	2.0
Deer Creek Channel	5.5
Day Creek Channel	7.0
Subtotal	34.0

<i>COMMUNITY</i>	<i>LENGTH (in miles)</i>
Almond Street	4.75
Hillside Road	4.5
Wilson/24th	8.5
Banyan/Summit	8.5
Highland Avenue	2.0
Southern Pacific R.R.	7.5
Victoria Park Lane	3.75
Terra Vista Greenway	2.75
Turquoise Avenue	1.25
Sapphire Street	1.25
Topaz Channel	0.75
Carnelian Street	1.25
Beryl Street	1.5
Amethyst Street	1.25
Archibald Avenue	2.25
Alta Loma Storm Drain	1.5
Hermosa Avenue	1.25
Haven Avenue	2.25
Etiwanda Avenue	2.0
W/o East Avenue	0.75
E/o East Avenue	0.75
W/o San Sevaine	1.25
E/o San Sevaine	0.5
Lower Loop	1.0
Subtotal	63.0
Grand Total	97.0

3.2 PRIMARY LOOP TRAILS

The Primary Loop trails form a figure "8" consisting of a combination of Regional and Community Trails, with Heritage Park centrally located at its mid-section. In this way, Heritage Park can be used both as a destination and a trailhead. With a total length of approximately 14 miles, and intercepted at regular intervals by Community Trails, it affords a limitless variety of trail experiences. The loop would also function as a means to access the major roads at each corner of the area. Although street crossings are unavoidable, the general exposure of trail users to vehicular traffic is as minimal as possible, and can be safely regulated by signing, pavement texture, and adequate sight distance.

The trail's predominant topography is relatively level, or with gradual inclines, and occasionally steeper grades where crossing ravines. Many of these trails will be contained within the flood control channel rights-of-way or public utility corridors which are more expansive and give a feeling of more openness. Regional Hiking and Riding Trails are located on both sides of the channel to maximize trail potential. Where the trails must run through narrower residential areas and within street parkways, existing Eucalyptus windrows and new landscaping will provide for an attractive trail experience.

The trip along the completed Primary Loop will give the user a varied and pleasant, as well as safe, recreational experience. Easy access to other Regional, Community and Local Feeder Trails, and specific points of interest, will encourage trail participation by various interest groups. Generally speaking, the Primary Loop trails should be given a higher priority for completion over other trail segments.

3.2.1 PRIMARY LOOP TRAILS DESCRIPTION

The proposed Primary Loop trails have been divided into geographic segments for description. The following numbers below correspond to the map in Figure 3.

1. **Demens Channel** - The Demens Channel section commences at the junctions of Amethyst Avenue and Almond Street. The trail follows the south side of the Demens Channel Debris Basin along the levee road, crosses Beryl Street, bisecting Heritage Park, and continues along the north side of the channel. The trail ends at a small rest area where the Demens Channel meets the Cucamonga Creek Channel. This is a relatively flat trail which passes through the heart of the Equestrian/Rural Area in Alta Loma. Special attention is needed to improving the crossings at Beryl, Carnelian, and Sapphire Streets with, at a minimum, signing and pavement texture. The natural surfacing is somewhat rocky and would benefit from rock removal and resurfacing with decomposed granite.

2. Cucamonga Creek

2a. At the junction of Demens and Cucamonga Creek Channels, the Primary Loop Trail turns north and follows the east side of Cucamonga Creek Channel, paralleling a private local feeder trail, to the southerly terminus of Turquoise Avenue (approximately at the level of Gardenia Street). From this point the trail would jog to the west around the backside of six residences along the west side of Turquoise Street to merge again with Turquoise Avenue at Pearl Street. This portion of the trail is very rocky and would require clearing and dressing of the trail surface.

2b. From Pearl Street, the trail would become a 20' parkway trail traveling north along the currently unimproved west side of Turquoise Avenue to the Almond Intercept Channel.

3. Almond Trail

3a. The Primary Loop Trail would turn northeast at the end and follow the existing dirt road on the south side of the Almond Intercept Channel to a junction with Almond Street just east of the Forest Service road which goes up into the San Bernardino National Forest and future Cucamonga Canyon Trail and Front Line Trail.

3b. Turning East at Almond Street (currently a dirt road) , the trail follows the road crossing Sapphire Street, and continuing along the south side of the paved road in a 20' parkway and drainage easement. Just west of Via Verde Street, a drainage channel crosses under the street, disrupting the parkway trail, and forcing trail users out onto the street unless a bridge is built.

3c. Almond Street becomes a non-dedicated County abandoned dirt road, still privately owned, just east of Via Verde Street. This dirt road continues through private property to Carnelian Avenue. The trail then becomes a fully dedicated and improved fire access road and Community Trail along the southerly border of the King Ranch Estates and Tract 11626 where it meanders north in a parkway condition to Angall's Canyon.

3d. Angalls Canyon and the adjoining Thorpe Canyon are privately owned. A 20' wide Community Trail exists through the westerly canyon and up across the plateau between the two canyons. This is one of the most scenic trail areas in the City; hence, trail improvements were kept minimal. Due to potential flooding, both canyons will most likely remain as open space areas.

3e. From the east side of Thorpe Canyon to Gooseneck Lane, an Offer of Dedication exists for Almond Street. The Forestry Department requires it to be kept cleared. The City can accept the dedication and convert it into a trail corridor linking the two flood control areas in which the other parts of this route lies.

3f. Beyond Gooseneck Lane is a short section of Almond Street which crosses Demens Channel and turns south to Amethyst Street. The surrounding Flood Control land is rocky and brush covered, but would lend itself readily to trail construction. The preferred alignment for the Primary Loop Trail to continue east would be to then cross to a Local Feeder Trail easement on the north side of Tract 9521, which empties onto Archibald Avenue. However, the 12' easement of Tract 9521 is privately owned, and horsekeeping is not permitted within this Tract, which may make acquisition of public trail rights difficult. Tract 9306 to the north likewise does not permit horses and is lacking any trail easements. Alternate routes above Tract 9306 or below Tract 9521 may be considered to make this valuable link. An existing dirt road atop the Demens Basin levee could extend the trail from Amethyst to the northeast as an alternate route above Tract 9306.

The Primary Loop Trail also would continue to the southwest on top of the levee to loop back to Heritage Park. From Amethyst, the trail will follow the levee around the south side of the basin and Demens Channel until reaching Heritage Park.

3g. Crossing Archibald Avenue, and progressing eastward, the route currently passes through a scenic expanse of undeveloped land: plateaus with vistas of valleys and mountains, several small canyons, and a large stand of Eucalyptus trees at Hermosa Avenue. The City has approved subdivision maps for these areas (Tracts 13316 and 12902) which will result in full dedication and improvement of a 20' wide Community Trail that will run just north of Carrari Street and continue northeast along the top of a steep bluff above the Eucalyptus grove until it meets with the future extension of Almond Street. The trail will turn eastward and run in the parkway for a short segment until it crosses Hermosa Avenue, where it joins a fully improved 20' Community Trail that meanders through a custom lot subdivision (Tract 12237) within the Eucalyptus grove. From there the trail will link up to a 10' Community Trail dedicated through Tract 10045-1 which connects the Primary Loop Trail to the Hillside Channel.

4. Hillside Channel is a fully improved flood control channel. The Primary Loop Trail heads southeasterly following the south side of the channel, crossing Haven Avenue and continuing to the confluence with Deer Creek Channel. This trail section would benefit from surfacing with decomposed granite and tree plantings.

5. The Primary Loop Trail then joins the north-south Deer Creek Channel. The trail runs south along the west side of the channel to the location where the Los Angeles Metropolitan Water District's line crosses (at the level of Banyan Street). Trail surfacing and tree planting is desirable.

6. The trail will leave Deer Creek Channel and proceed westward within the Metropolitan Water District's (MWD) 80 foot wide permanent easement (following the south side of Banyan Avenue), which crosses Haven and Hermosa Avenues. Between Haven and Hermosa Avenues, there lies the Alta Loma Storm Drain Basins where the Primary Loop Trail jogs briefly north along Haven Avenue in the westerly parkway and then turns west to follow an existing fully improved Community Trail that runs on top of the basin levee until it crosses

Figure 3: PRIMARY LOOP TRAIL MAP

Note: The numbers correspond to the text descriptions. This map is not intended to show all Regional or Community Trail locations. A complete map of the entire trail system is shown in Figure 2: *Hiking & Riding Trails Master Plan*.

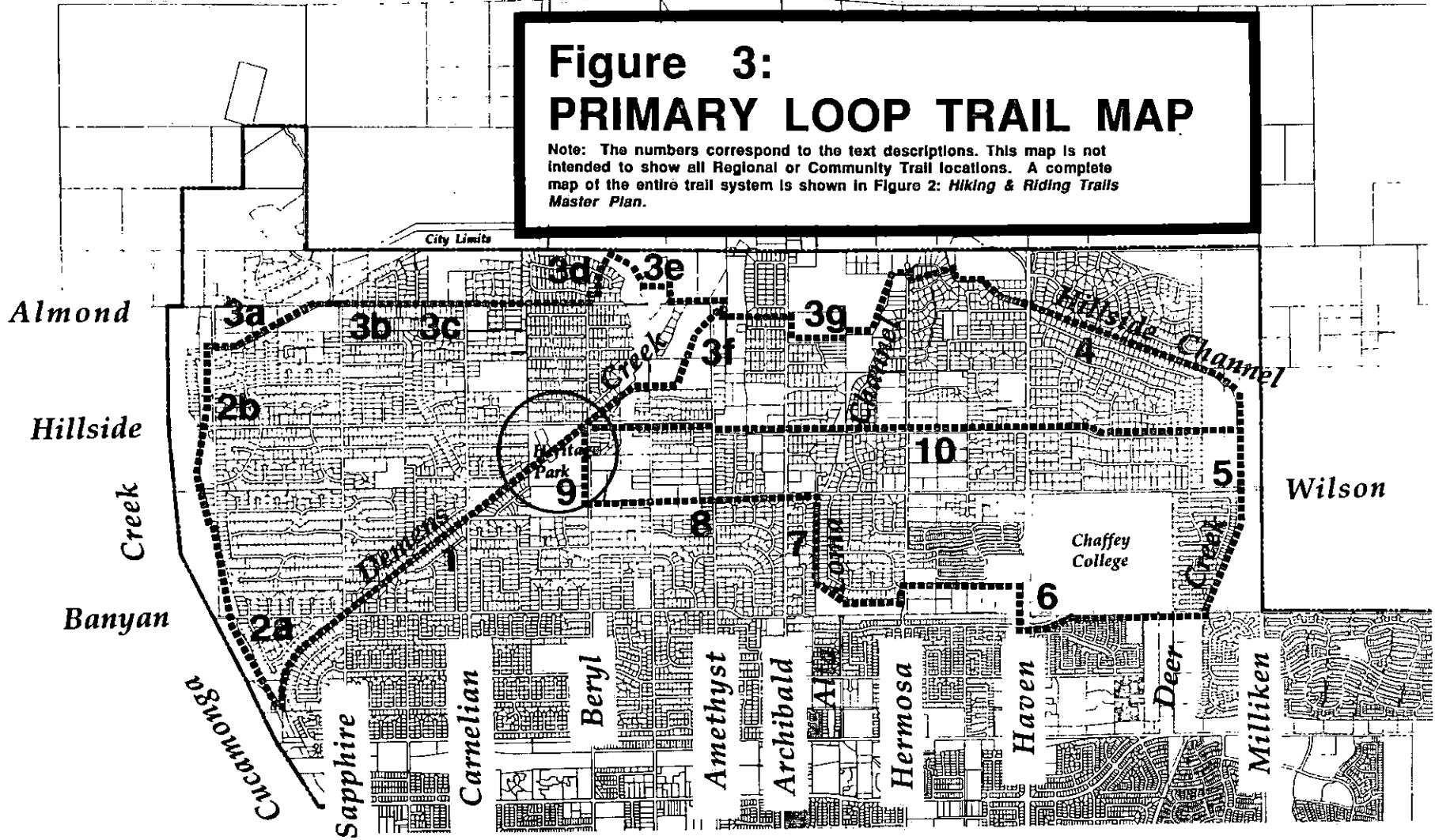

Hermosa Avenue to meet with the Alta Loma Flood Channel.

7. At the Alta Loma Flood Control Channel, the Primary Loop Trail would follow north alongside the concrete channel. A bridge is needed to cross over the channel, approximately at the level of Coca Street. The trail route eventually intersects with the Wilson Avenue parkway trail where it continues on the south side to Amethyst.

An alternate route would be to continue the trail from the MWD easement, where it intersects with Banyan Street one block east of Archibald, and run within the existing parkway on the north side of Banyan to the west side of Archibald. This would eliminate a mid-block crossing of Archibald. This route would also maximize the existing right-of-way which crosses the corner sideyard of one lot and the front yard of three lots rather than trying to acquire public trail rights from dozens of private property owners. From this point the trail would head north within the existing parkway Community Trail, to Amethyst. At this point the trail could follow either of the following routes: north to Hillside, then west to Heritage Park; or south to link up with the Manzanita trail described above.

8. From Amethyst, the trail will continue to follow the south side of the future Wilson Avenue until it reaches Beryl Street. Wilson Avenue is proposed to be extended as development occurs through this segment.

9. Upon reaching Beryl Street, the Primary Loop Trail then turns north, following the west parkway to Heritage Park at Hillside. The undeveloped and unlandscaped condition of the parkway does make current trail use possible. However, users must cross Beryl at Manzanita Street, to continue up the west side of Beryl because of an impassable flood channel which empties onto Beryl from the northeast. Improvements along this stretch of the Primary Loop trail would include full construction of a Community Parkway Trail, including landscaping and crossing treatment at Manzanita. The Community Trail is complete within the Heritage Park frontage of Beryl Street.

10. Hillside Road - See comments under Community Trails.

3.3 COMMUNITY TRAILS

The existing pattern of Local Feeder Trail easements necessitates Community Trails along most major streets within the Equestrian/Rural Area as secondary trail routes. These Community Trails function as collectors that link the Local Feeder Trail Network with the Regional Trail system. The Community Trails are vital to the implementation of an interconnected trail system. When completed, these trails will provide an infinite number of trail route possibilities, from short jaunts to long loops throughout the community. For hikers, the Community Trail system will extend via public sidewalks into all portions of the City, providing access to shopping centers, community facilities, and parks.

Parkway trail design and development must accommodate both pedestrian and equestrian travel in order to meet the General Plan objective as a non-vehicular circulation element. In most cases, the Community Trail provides a single trail path that is shared by hikers and equestrian riders. Parkway trails also offer certain advantages as trail routes: 1) easy access for development and maintenance; 2) good visibility for monitoring; 3) economical acquisition; and, 4) extended trail use time during winter daylight savings time because of street lighting.

3.3.1 COMMUNITY TRAIL DESCRIPTIONS

The following areas are in need of attention in order to achieve an integrated trail system (numbers correspond to the map shown in Figure 4) :

1. Sapphire - The parkway on the west side, from Jennet north to Almond, has no parkway trail accommodations in some places, and just concrete sidewalks in others, which forces trail users, particularly horsemen, out onto the street.
2. Carnelian - The west side of the street, north of Thoroughbred Street, to Almond Street, has an 11' parkway, but landscaping does not permit pedestrian or equestrian use (with the exception of a short sidewalk just north

-
- of Hillside). The east side of the street, north of Hillside Road, is less developed and offers greater opportunity for a trail.
3. **Amethyst** - North of Banyan, some unusable parkway exists on alternating sides of the street. However, from Manzanita Drive north, all pedestrians and equestrians must use the street.
 4. **Alta Loma Channel** - This trail originates at the confluence of several small streams northwest of Hermosa and Almond, passes through a large Eucalyptus grove (Tract 12902) and links with the channel service until it reaches the Alta Loma Storm Drain Basin, just north of Banyan. The County Flood Control District has fenced in the channel right-of-way which will require negotiation of a joint-use agreement for recreational purposes and construction of appropriate vehicle barriers in several locations that will allow pedestrian and equestrian access.
 5. **Wilson** - From Amethyst to Alta Loma Channel, a Community Trail exists. From Hermosa east to Deer Creek Channel, a Community Trail will be installed as development occurs. A private trail exists in the parkway on the north side of Wilson east of Haven, which is maintained by the Deer Creek Estates Homeowner's Association. A bridge across Deer Creek Channel will ultimately be constructed to extend Wilson to the east which should be designed to accommodate the trail.
 6. **Hillside** - East of Haven, most of the land has been developed with provision for trail access in "frontyard" trails. Unfortunately, the majority of Hillside was developed prior to incorporation without provision for trail access, and the proposed trail route would run through the frontyards of many homes. Hillside is becoming an ever-increasing traffic and trail corridor, due in large part to the recent completion of Heritage Park on the southwest corner of Hillside and Beryl. To convert existing road rights-of-way into a usable parkway trail will be an involved but rewarding task.
 7. **Banyan** - This trail forms the southerly boundary of the Equestrian/Rural area in Alta Loma. Short segments of the Banyan Trail are improved; however, the portion between Sapphire and Amethyst is developed without trail access. Like Hillside, the conversion of frontyards and corner side yards into a Community Trail will be a major effort.
 8. **Beechwood** - The Beechwood Trail, which becomes the Wilson Trail east of Beryl, is the first east-west Community Trail north of Banyan; hence, is a cross-town linkage from the Cucamonga Creek Channel Regional Trail to the Deer Creek Channel Regional Trail. This trail presently consists of a continuous stretch of private equestrian easements, except for one lot (Lot 26 of Tract 9015) on the west side of Jasper below the Floyd Stork Elementary School.
 9. **Turquoise** - See comments under Primary Loop Trail.
 10. **Beryl** - This existing Community Trail follows the east side of Beryl from Hillside north to Almond and provides an important linkage from the equestrian center at Heritage Park to the Front Line Trail (via the Community Trail through Tract 11626). Portions of the parkway are too narrow (7 feet) or have been overgrown with vegetation which forces horsemen out onto the street.
 11. **Archibald** - North of Banyan, the Community Trail exists on the west side up to Wilson where it will continue northerly until Hillside Road. From Hillside north to Cinch Ring Lane, there is an existing private trail that could potentially be acquired for public trail use. As an alternate route, the trail could cross over to the west side just below Whirlaway Street and continue up to the Front Line Trail. The City is preparing a beautification study for Archibald which may result in expanded parkways and a potential trailhead at the City limit.
 12. **Hermosa** - From the Alta Loma Storm Drain Basins to Wilson, there is an existing parkway trail following a Eucalyptus windrow. The trail will be extended along the west side until it joins the Almond Trail. A short, scenic segment meanders along the intermittent creekbed through the Eucalyptus grove at the top of Hermosa (part of Tract 12902).
 13. **Haven** - North of Haven, an expansive parkway includes a riding trail built as part of the Deer Creek Subdivisions up to the Hillside Channel Regional Trail. To provide a safe and convenient trail system, there will be a trail on both sides of Haven, north of Wilson.
-

Figure 4: COMMUNITY TRAIL MAP

Note: The numbers correspond to the text descriptions. This map is not intended to show all Community Trail locations. A complete map of the entire Community Trail system is shown in Figure 2: *Hiking & Riding Trails Master Plan*.

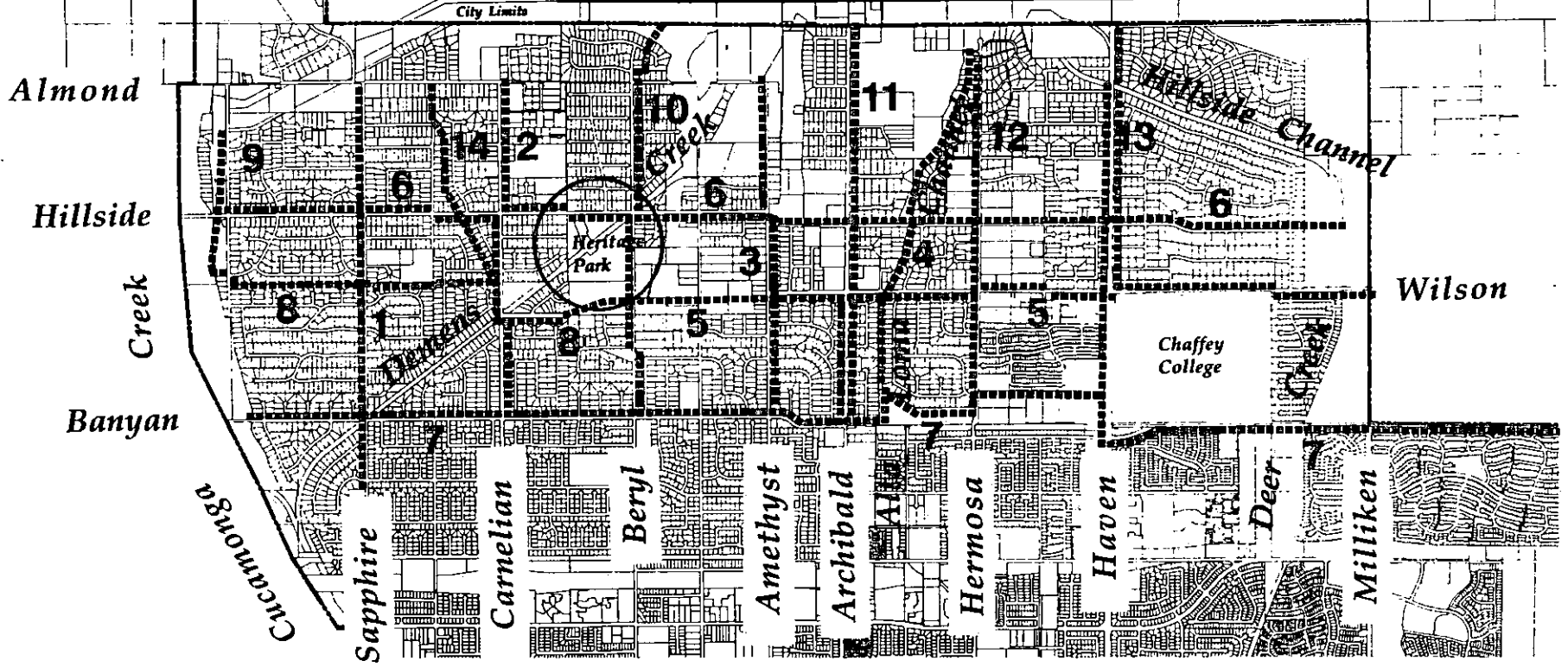

14. **Topaz Channel** - An existing private drainage easement runs from Carnelian to Almond which has the potential of being converted into joint use as a trail.

3.4 LOCAL FEEDER TRAILS

The Local Feeder Trails takes the trail system down to its most intimate level. These trails, which are not identified on the *Hiking and Riding Trails Master Plan*, are contained within each subdivision in the Equestrian/Rural Area, and provide the trail user access from the rear of each lot to the Community Trails. The Local Feeder Trails are private easements that are established at the time of subdivision review. In addition to the general trail locational guidelines mentioned in Section 3.1, the following criteria should be used in locating Local Feeder Trails:

- Provides access to the rear of every lot, wherever possible.
- Provides convenient access to the Community or Regional Trail system.
- Provides a logical riding loop within the subdivision.
- Provides a missing link to connect with other surrounding trails.
- Discourages mid-block crossings wherever possible.

3.5 TRAIL HEADS

At key locations along the regional and community trail system, provision should be made for trail head facilities. These trail heads will function as staging points for hikers, bikers and riders, and be equipped with facilities, such as restrooms, drinking fountains, parking for cars and horse trailers, watering troughs for horses, hitching posts, bike racks, benches, and shade. An example of a limited facility trail head exists at the confluence of Cucamonga and Demens Creeks. Heritage Park provides all of the amenities typically associated with a trail head. Probable locations for these facilities would be at the base of the foothills, to be used as a staging area for persons desiring to strike up into the foothills, such as along the Front Line Regional Trail. In addition, two trail heads are being proposed as part of the *Etiwanda North Specific Plan* for the Sphere-of-Influence area above the Etiwanda community. Also, a trail head is being proposed in conjunction with the *Hunter's Ridge Specific Plan* development adjoining the City limits with the City of Fontana, north of 24th Street.

3.6 EQUESTRIAN FACILITIES

The majority of north Alta Loma and Etiwanda, including the City's Sphere-of-Influence, is designated as an "Equestrian/Rural Overlay District." This area is characterized by larger single family lots intended for the keeping of animals to promote a "gentrified" rural lifestyle. To service the needs of the equestrian trail users, it is recommended that equestrian centers be provided with riding rings and training areas, in addition to those amenities in the trail heads. In particular, the equestrian centers should be designed to accommodate horse shows with appropriate facilities, such as judging stands, seating and parking.

The existing equestrian center located in Heritage Park adequately serves the Alta Loma community. An equestrian center is needed to serve the Etiwanda area, and is being proposed as part of the *Etiwanda North Specific Plan*. The equestrian center could be developed and operated as a private concession under lease to the City. Equestrian centers may also be located within a subdivision and operated as a private facility by a homeowners association. The optional development standards within the *Etiwanda Specific Plan* encourage clustering of homes to create common open space areas which can be used for this purpose.

Public parks which have trail access should provide trail related amenities to encourage trail usage, specifically hitching posts and watering troughs. The City should also consider establishing a horse boarding and rental facility on City owned parkland to provide the general public with the opportunity to experience horseback

Mojave Narrows Regional Park. Ideally, such a facility would be located at the base of the foothills to take a full advantage of that areas scenic trails. The facility must have direct access to a Regional or Community Riding Trail, preferably at or near the crossroads of two trails to provide a variety of ride options.

3.7 EXERCISE STATIONS

In conjunction with, or separate from, the public parks, the City should provide exercise stations along the regional and community trail system. Heritage Park is an example of the type of exercise stations that can be provided along a trail that encourages greater trail use. Typically, the trail user performs a different set of exercises at each station, such as sit-ups, step-ups or pull-ups, and jogs or walks to the next station. The stations are arranged in a course designed to exercise all of the bodies major muscle groups and provide aerobic activity.

For equestrians, the Alta Loma Riding Club has proposed to build an exercise course on unused land within Heritage Park. The facility is designed to provide training for both the rider and the horse, with emphasis on trail riding safety. Individual stations feature equipment to acquaint the rider and the horse with the various conditions and obstacles they may encounter, such as stepping around or over objects.

3.8 CROSSINGS

3.8.1 FREEWAY CROSSINGS

In the following locations, the Regional or Community Hiking & Riding Trails must cross the future Foothill Freeway (Route 30) right-of-way. Regional Trails along Cucamonga Creek, Deer Creek, and Day Creek Channels all cross the Foothill Freeway. Since these trails utilize existing flood channel rights-of-way, trail access can be maintained by providing a minimum 10 foot wide path (10 foot overhead clearance) alongside the channel box underneath the freeway. In addition, a Community Trail along Etiwanda Avenue, and one Community Trail through the San Sevaine basins, must cross the proposed freeway corridor. The preliminary design profile of the freeway indicates that Etiwanda Avenue will become an overpass above the freeway; hence the trail would continue across the freeway within the west parkway. The City should continue to work with Caltrans to coordinate appropriate trail crossings at these locations in order to maintain an interconnected trail system.

3.8.2 FLOOD CHANNEL CROSSINGS

To maintain the integrity of the Regional Hiking and Riding Trail System, the trails along flood control channels must eventually cross underneath major streets and rail lines. Because the Regional Trails are multi-purpose and serve hikers, equestrians, and bicyclists, the need for crossings affects all trail users. Where these crossings occur, an underpass is generally recommended. The proposed underpass locations are shown in Figure 6. In the Equestrian/Rural Area (e.g. - north of Banyan), it is desirable to provide hiking and riding trails along both sides of the channels; hence, underpasses would occur on both sides as well.

Day Creek Channel represents the Citys' greatest opportunity for a truly Regional Trail. Both Cucamonga and Deer Creek are effectively cut-off by the Ontario Airport to the south. Thus Day Creek is the only channel with the potential to continue south to link up with other regional trails, such as the Santa Ana River Trail. Therefore, emphasis has been placed on planning for underpasses along Day Creek Channel. However, Day Creek Channel is not without its own limitations. Where the channel crosses Arrow Route there is a 36" gas line that precludes any underpass and will necessitate an at-grade crossing with specially designed signals activated by trail users. Likewise, a surface crossing must be used where Day Creek Channel crosses the A.T. & Sante Fe rail line, because an underpass cannot be constructed there.

At key locations, it may be desirable to provide bridges across flood control channels to facilitate and maintain the continuity of the Regional or Community Hiking & Riding trail systems. Therefore, wherever the master planned trail system must cross a flood channel, an appropriate bridge crossing should be provided. The trail bridge may be separate from the roadway bridge. Two such bridges exist across Deer Creek Channel within Terra

bridge may be separate from the roadway bridge. Two such bridges exist across Deer Creek Channel within Terra Vista as part of that master planned community's trail system. A bridge is needed at the westerly terminus of the Victoria Park Lane trail across Deer Creek Channel to link the Victoria Planned Community with homes on the west side of the channel and provide a safer, shorter route to school. A bridge across Cucamonga Creek will be built as part of the Don Tapia park project, south of Base Line Road, which will connect the Regional Hiking, Riding and Biking Trails on the east side of the channel with the park and provide trail access for Red Hill residents.

**BICYCLE TRAILS
CONCEPT**

4



BICYCLE TRAILS CONCEPT

"Recreational bicycle, pedestrian and equestrian routes can play a major role in the efficient circulation of people. As part of the transportation network, the City has enacted a Master Plan of Trails to provide a system of safe, functional bicycle, pedestrian, equestrian, and recreational routes along roadways and amenities to encourage their use in order for Rancho Cucamonga to meet non-auto transportation needs in the future."

— General Plan, p. III-85

4.1 OVERVIEW

The City of Rancho Cucamonga's General Plan, and other specific or community plans, call for the development of an extensive system of bicycle facilities. Bicycling has, and will continue to, increase in Rancho Cucamonga, as it has nationally. An estimated 90 million people in the United States (one out of every three) rode a bicycle in 1989, according to the Bicycle Institute of America (BIA). The total number of people riding bikes has risen 22.2 percent in the last six years. The growth of bicycling can be attributed to the American public's desire to stay fit, the widespread popularity of all-terrain (fat tire) bikes, which are more comfortable to ride. The BIA's data indicates that there were 20 million regular bicycle riders, 2.7 million bicycle commuters, and 7.5 million mountain bicyclists in 1988.

The primary concern of this plan is to provide citizens with the opportunity to bicycle safely and conveniently. An effort has already been made in the provision of a bicycle route system in Rancho Cucamonga. Approximately 2 miles of shared-road bicycle routes exist. In addition, the City has joint-use agreements with the County Flood Control District for 9 miles of bicycle trails (service roads) along Cucamonga and Demens Creeks, and the Alta Loma Storm Drain and Basins. Therefore, this plan focuses upon adapting the existing and proposed street system and flood channel/utility corridor system to bicycle travel.

4.2 TRIP TYPES

Bicycling opportunities may be divided into two varieties: destination and non-destination. Identifying the purpose of the trip and the ultimate destination is as important as identifying the type of rider for the purpose of bicycle trail planning. People who bicycle to work, school, personal business (shopping, banking), or to recreational facilities are "destination" oriented. Non-destination bicycling would include riding around the neighborhood (less than two hours with no destination in mind), and bicycling long distances for fun or training (over two hours with no particular destination in mind).

In laying out a bicycling trail system, there are four major types of attractions or "destinations":

- ❑ Major Retail Concentrations - Trips made for personal business are primarily attracted to neighborhood shopping centers and large malls. Access is seldom easy to these areas because they are located on busy arterial streets. Neighborhood shopping centers are typically only minutes, by bicycle, from home; however, it would require a rack, backpack or trailer to transport most purchased items.
- ❑ Schools/Libraries - Elementary schools are located within neighborhoods and generally do not require bike route improvements to provide access. Junior/Senior High Schools, Colleges and Libraries are typically located on major arterials and would require improved access.

-
- ❑ Recreational Facilities - City parks such as Heritage or Red Hill, and Central Park in the future, can be considered major bicycle trip generators. Many casual riders are attracted by the opportunity to ride off-street on the many paths throughout these parks. Regional parks, such as Cucamonga-Guasti, are intended to be accessible via the regional bicycle trail system that will follow the many flood control channels and utility corridors.
 - ❑ Major Employment Centers - The industrial area below Foothill Boulevard is the largest employment concentration in Rancho Cucamonga. Access to this area can be accommodated by expanding the shoulder width on major arterials leading into the area. Because of the size and shape of the City, a large number of people live close enough to work to commute by bicycle. However, it is estimated that only a very small percentage actually do so at present, which may be attributed, in part, to an incomplete roadway (and trail) system.

4.3 PHYSICAL CONSTRAINTS TO BICYCLE USE

The continuity of streets is important in deciding the potential for accommodating bicycle use. One of the factors which contributes to the large volume of vehicle traffic on arterials is the fact that they provide direct and continuous access to trip generators (destination points). It can be assumed that cyclists on destination trips will choose these routes for the same reasons as vehicle drivers. There are a number of concerns with the present street system as it relates to bicycle trail potential:

- ❑ Many of the major arterials are undesirable at this time because they have not been improved to their ultimate width. For example, Base Line Road and Highland Avenue are major east-west cross-town corridors which are essentially two-lane rural highways, east of Haven Avenue. At present, these streets are used extensively by bicyclists due to a lack of suitable alternate routes.
- ❑ In the eastern part of the City, many streets are characterized by high speed vehicular traffic (50 mph typical). This includes, Foothill Boulevard, Base Line Road, Highland Avenue, and Arrow Route. This factor, coupled with the inadequate improvements (lack of sufficient shoulder), creates an unsafe riding environment.
- ❑ New development construction and City capital improvement projects have interrupted streets throughout the community, creating a confusing and dangerous situation for bicyclists, particularly destination riders.
- ❑ There is very little in the way of bicycle trail improvements, such as lane striping and trail signs, to call attention to the trail system.
- ❑ Foothill Boulevard - Just west of Baker Avenue, there is a railroad overpass which creates a dangerously narrow roadbed through a short tunnel. This is a significant barrier to bicyclists.
- ❑ Flood Control Channels - The majority of the planned Class I Bike Paths are regional trails which follow flood control channels. A lack of crossings (bridges, culverts, etc.) at intersections with major streets represents a serious limitation to their use as regional trails.
- ❑ Milliken Avenue - Planned as the major north-south access east of Haven Avenue, this arterial will run through the heart of the industrial area which represents a potential major bicycle commuter destination. Presently, there are significant gaps in the continuity of this street. A major railroad underpass is needed between 6th Street and Arrow Route, which, until completed, represents a barrier to cyclists.
- ❑ Maintenance of street surfaces used by bicyclists is important to the safe and convenient use of the roadway for bike trails. The conditions of the pavement on the shoulder, where bicyclists ride, is also important. Crumbling, irregular asphalt, pot holes and cracks, uneven joining of the street pavement to the gutter, and debris does exist. Rancho Cucamonga is also subject to seasonal high winds, especially during December and January, depositing sand and dirt on the roadway that is slippery for cyclists.

Another factor affecting bicycle trail use is the availability of secure and convenient bicycle storage. This is of particular concern for commuting, shopping, and even trips to the park or school because the bike must be left unattended for an extended period of time. San Diego encourages commuting by bicycle by providing bicycle storage facilities at key destination points. More than 475 lockers are available for rent at park-and-ride sites, mass transit stops, and government buildings throughout San Diego County. A recent survey of bicycle commuters revealed that they saved an average of \$750 each year and more than 43,500 gallons of gasoline. Employers should be encouraged to provide all-weather storage lockers for bicycles. City ordinances requiring bicycle storage racks should be expanded to relate the number of racks to the size of the development.

4.4 BICYCLE TRAIL POLICIES

The following policies are adopted for the bicycle trail system:

1. Principal trip destinations, such as, schools, parks, community centers, employment centers and shopping centers shall be linked via bike trails to residential areas.
2. All bicycle trip destinations shall be equipped with bike storage to encourage using bicycles as an alternative mode of transportation.
3. The bicycle trail system should meet the demands of both the recreational and experienced cyclist.
4. Transportation projects and land development proposals should consider, and address, bicycle trail needs.
5. Adequate traffic control devices shall be provided for bicycle crossing.
6. Off-street bicycle trails should use open space corridors, flood control and utility easements, and minimize automobile cross traffic where possible.
7. Require provision of village level bike trail systems by developers of planned community / specific plan areas, and their connection to the city-wide network.
8. Bicycle storage lockers should be provided in major employment centers.
9. Storm drains along public streets with bike trails should be designed with curb-face inlets or bicycle-safe grates (non-parallel bars) to prevent tires from getting trapped.
10. Railroad crossings on public streets with bike trails should be designed with rubberized pads in the outside lanes to prevent bicycle tires from getting trapped.
11. Class II and III bike trails along public streets should be planned and designed for one-way bicycle travel.

4.5 BICYCLE TRAIL SYSTEM

The accompanying *General Bikeways Plan* (see Figure 7), identifies those locations where bicycle trail facilities are recommended or the type of bicycle trail identified for each route is the one which may ultimately be appropriate in that location. This plan does not intend to limit a bicyclist's right to use other roadways, its goal is to develop a system of recreational trails which can be used by cyclists of all types. Approximately 34 miles of Class I, off-street bike paths are planned. Almost 32 miles of Class II, striped bike lanes are proposed. The *General Bikeways Plan* proposes 34 miles of Class III designated bike routes. See summary in Table 2.

Not all streets for which bicycle trails are recommended require immediate implementation of the bicycle facility indicated. As the community grows and the potential for bicycle use increases, a street may be signed first as a designated (Class III) route and later striped for on-street bicycle lanes (Class II). On some streets, there may be several options available for which special factors may prevent a determination of the appropriate facility at this time. A detailed description of the design of the three types of bike trails is contained in Chapter 6.

Table 2: BICYCLING TRAIL SUMMARY

<i>CLASS I BIKE PATH</i>	<i>LENGTH (in miles)</i>
Terra Vista Greenway	1.25
24th Street	2.75
Demens Creek	2.0
Cucamonga Creek	6.5
Hillside Channel	2.0
Deer Creek Channel	5.5
Day Creek Channel	5.0
Etiwanda Avenue	2.0
Southern Pacific R.R.	7.5
Subtotal	34.5

<i>CLASS II BIKE LANE</i>	<i>LENGTH (in miles)</i>
24th Street	0.5
19th Street	3.75
Victoria Park Lane	3.0
Base Line Road	6.5
Miller Avenue	1.0
Pioneer Way/Rochester	0.5
Arrow Route	6.75
4th Street	4.75
East Avenue	2.0
Etiwanda Avenue	3.0
Subtotal	31.75

<i>CLASS III BIKE ROUTE</i>	<i>LENGTH (in miles)</i>
Hillside Road/Wilson Avenue	6.5
Banyan Avenue	6.0
Highland Avenue	3.0
Victoria Street	1.5
Terra Vista Parkway	1.75
Church Street	2.25
Beryl Street	2.25
Archibald Avenue	6.0
Milliken Avenue	5.0
Subtotal	34.25

Grand Total	100.5
--------------------	--------------

4.5.1 CLASS I BIKE PATH SYSTEM

Ideally, regional bike trails should be Class I routes; hence, the *General Bikeways Plan* calls for bike paths along the many flood control channels and utility corridors that criss-cross the community. A Class I bike path should be routed to make as few intersections with automobile traffic as possible. It is also preferred that bicycle traffic and pedestrians not be mixed, except where additional path width is provided.

Where bike paths are proposed along flood control channel rights-of-way, the bike path makes use of the paved service road that typically exists along one side of the channel. Figure 5 illustrates these locations as they existed in April 1990. Based upon a number of factors, such as intensity of trail use or physical constraints, the City may deem it necessary to locate a bike path on both sides of certain flood channels. Where flood channel bike paths cross major streets, an underpass is generally recommended. However, due to their high cost, alternatives may be used in some locations, such as a short bypass bike trail. Recommended underpass locations are shown in Figure 6.

The General Bikeways Plan indicates that the Class I Bike Paths must cross the proposed Foothill Freeway (Route 30) at several points. To maintain the integrity of the Regional Trail system, these Bike Paths should cross under or over the freeway. Fortunately, the Bike Paths follow the existing flood control service roads which will presumably be accommodated in the freeway design.

4.5.2 CLASS II BIKE LANE SYSTEM

In many situations, especially in developed areas, Class I Bike Paths are not physically possible due to physical constraints. Class II Bike Lanes may provide good on-street recreational cycling in these areas. High priority should be given to locating Bike Lanes on streets with the following characteristics: access to, or through, major employment centers, scenic qualities, acceptable grades, safe intersections, directness of route, and pavement width sufficient to handle the volume of bicycles and automobiles on the route.

The Class II bicycle trail along East Avenue must also cross the future Foothill Freeway. The City should continue to work with Caltrans to coordinate appropriate section width where this street must cross under or over the freeway.

4.5.3 CLASS III BIKE ROUTE SYSTEM

Class III routes (signed only) are recommended where streets otherwise meet the criteria for a Class II Bike Lane, but traffic levels and speeds are low, and there is not sufficient width to stripe a separate lane. Class III Bike Routes are especially suitable for streets with less than 1,000 vehicles per day and speeds of less than 40 m.p.h.

The Class III Bike Routes along Milliken Avenue and Archibald Avenue cross the Foothill Freeway. Sufficient street section must be maintained across the freeway corridor to retain an interconnected bike trail system.

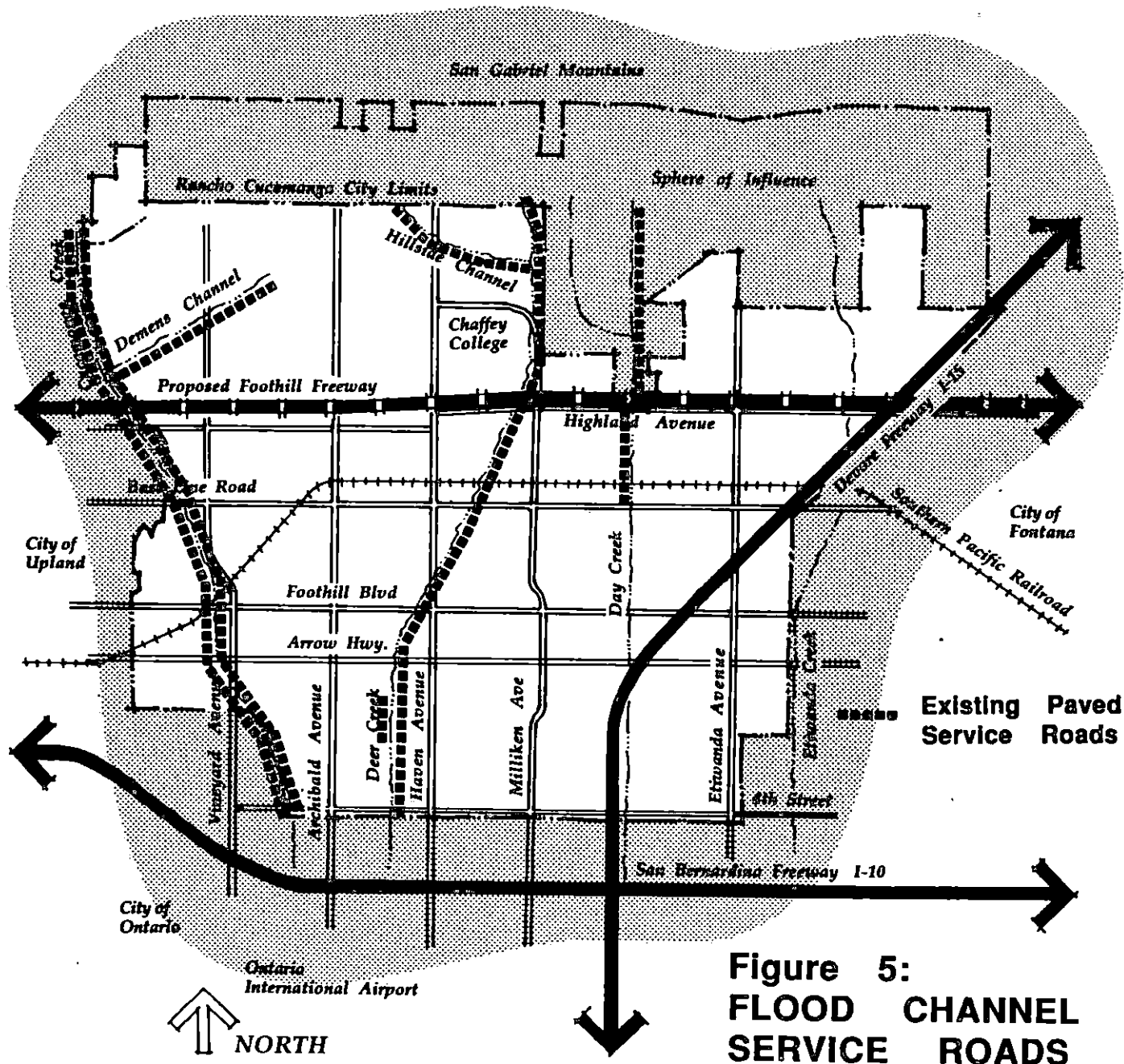

Figure 5:
FLOOD CHANNEL
SERVICE ROADS
 Based upon field survey April 1990

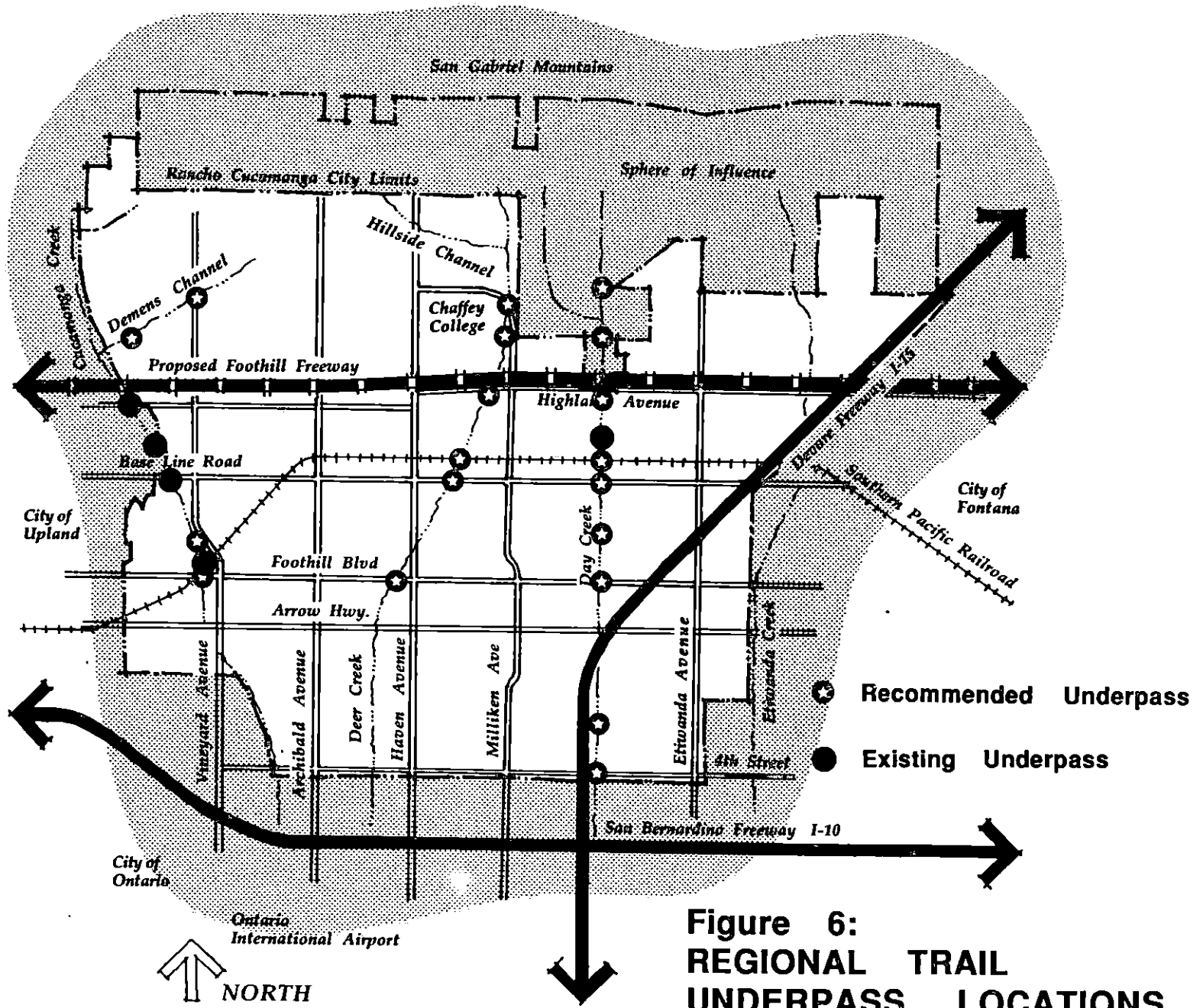
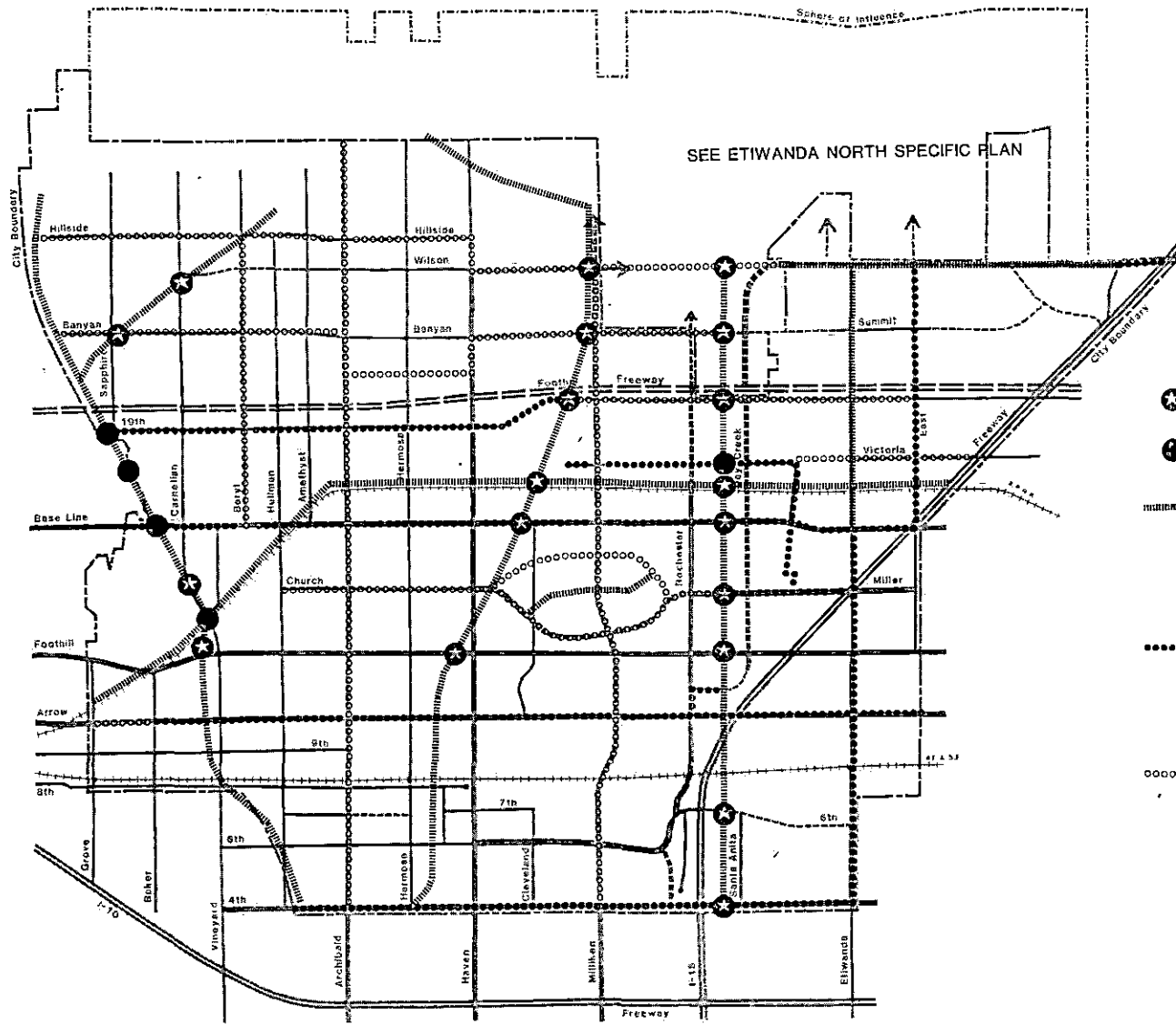

Figure 7: GENERAL BIKEWAYS PLAN



LEGEND

★ Proposed Street Undercrossing

● Existing Street Undercrossing

----- Class I (Bike Path): A bike path is a special pathway designed for the exclusive use of bicycles, which is "off-street" and separated from motor vehicles by space or a physical barrier. A bike path may parallel a street or highway right-of-way or may be a special right-of-way, such as a flood control channel; it may be grade separated or have street crossings at designated locations. It is identified with guide signing and may also have pavement markings.

..... Class II (Bike Lane): A bike lane is a lane on the paved area of a road for preferential use by bicycles. It is usually located along the edge of pavement or between the parking lane and the first motor vehicle lane. It is identified by "Bike Lane" guide signing, special lane lines and other pavement markings. Bicycles have the exclusive use of a bike lane except for motor vehicle and pedestrian crossings.

○ Class III (Bike Route): A shared route is a street identified as a bicycle trail by "Bike Route" guide signing or pavement markings. The shared route has no barrier, either symbolic or physical, to delineate from the roadway for bicycles. Bicycle traffic shares the roadway with motor vehicles. The outside traffic lane becomes the width required for motor vehicle travel, usually 10 or 11 feet, plus the 5 foot bikeway.

CITY OF RANCHO CUCAMONGA

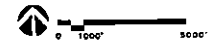

SPHERE OF
INFLUENCE

5



SPHERE OF INFLUENCE

Trail opportunities available within the City's Sphere of Influence are presently limited to informal use of public utility corridors and open, undeveloped land for hiking, equestrian, mountain biking and motorcycle use. The semi-improved Forest Service Trail IN34, located north of Almond, west of Sapphire, is the single exception. A number of graded fire roads also crisscross the San Gabriel Mountains north of the City (See Figure 8).

The San Gabriel Mountains have been experienced by horseback riders and hikers since the turn of the century. In the last few years, the area has become popular with mountain bicyclists. The United States Forest Service governs the San Bernardino National Forest and monitors the appropriateness of trail use by these different groups. The Forest Service may adopt policies restricting trail use within certain areas due to fire hazard or user conflicts, particularly Wilderness Areas and the Pacific Crest Trail. The Sphere-of-Influence area between the northerly City limits and the National Forest lies under the jurisdiction of the California Department of Forestry. The area is open to hikers, riders and mountain bikers, except for the Texas Fire area that is temporarily closed for revegetation.

In the 1960's San Bernardino County adopted a General Plan for Regional Parks that identified the area between Day and Deer Creeks as possible regional park site. The land is currently owned by the County Flood Control District and is designated for Rural Conservation by the *West Valley Foothills Community Plan*. The site was further identified on the City's General Plan as the "Chaffey Regional Park." Unfortunately, the park has not been funded and its future is uncertain due to a long term lease granted by the County Flood Control District for a sand and gravel mining operation.

The *San Bernardino County Master Plan of Equestrian and Hiking Trails* adopted in 1975 calls for a regional east-west trail at the base of the foothills. Known as the Front Line Trail, the general alignment is indicated in the *West Valley Foothills Community Plan* (See Figure 9), as well as the City's *Master Plan of Trails*. Basically, the trail follows a U.S. Forest Service fire control road which would ultimately connect San Antonio, Cucamonga, Deer, Day, and Cajon Creeks from San Antonio Dam easterly to Glen Helen Regional Park; approximately 27 miles in length. The Front Line Trail will provide access to beautiful foothill canyons and the National Forest. The appeal of the area includes valley vistas, secluded oak and sycamore studded canyons, natural springs and streams, and many forms of wildlife and native vegetation. However, County policy precludes the mandatory improvement of trails through development applications, until a local special district, improvement zone, or assessment district with appropriate powers, has been established.

The City of Rancho Cucamonga is encouraging annexation of the Sphere of Influence into the City. Several hundred acres of land have already been annexed which will include trail systems. Presently, the City is working with a consortium of property owners within the Sphere of Influence who are proposing a specific plan to govern the development of that area above the Etiwanda community. An extensive trail system is proposed as part of the *Etiwanda North Specific Plan*.

The City should continue in its efforts to work with the County and land owners within the Sphere-of-Influence through the specific plan, annexation, and subdivision review processes to negotiate trail alignments, improve ments, and establish maintenance districts. Annexation and Development Agreements are, and have been, an effective implementation tool for expanding the trail system into the Sphere of Influence.

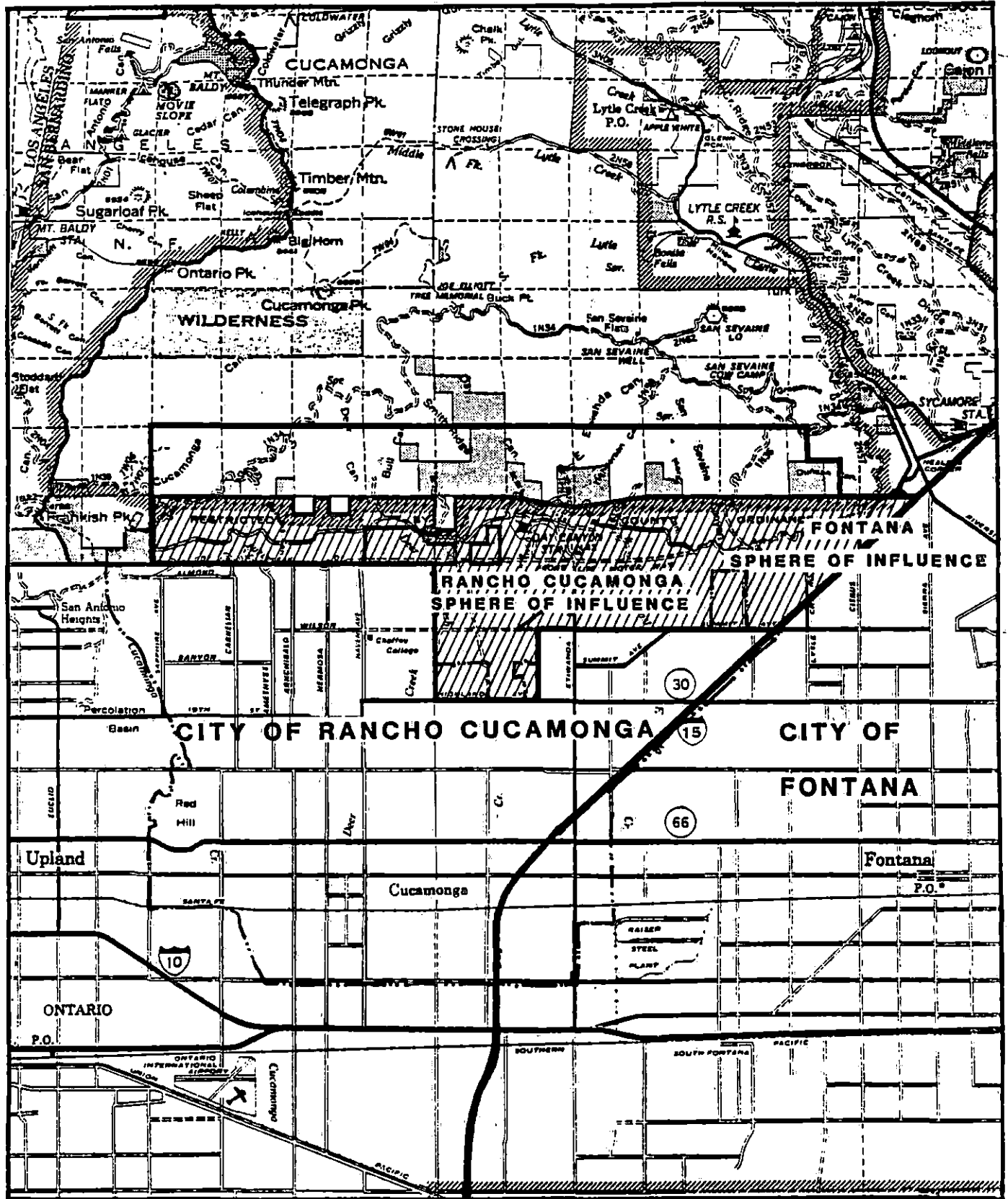
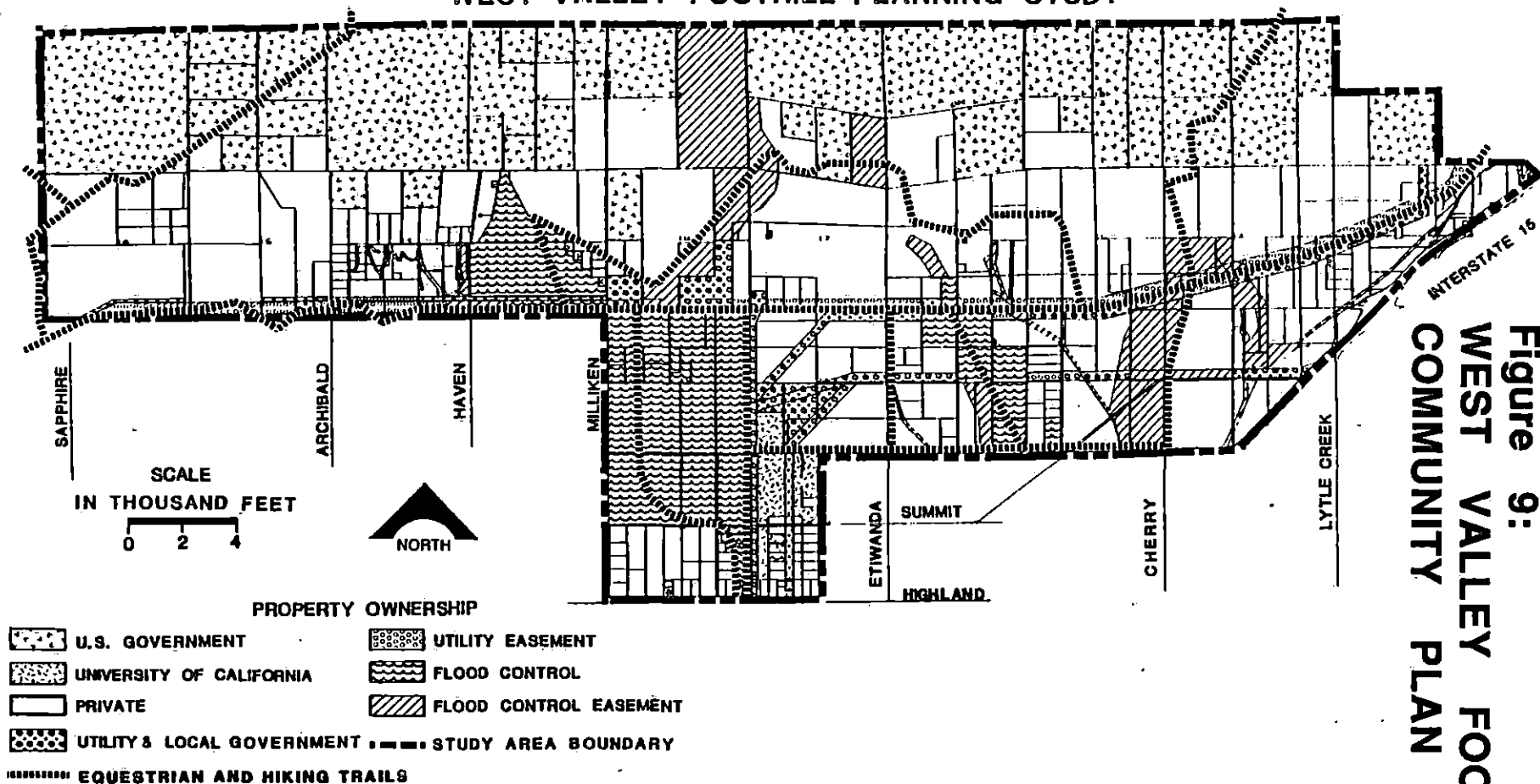

**Figure 8:
SPHERE OF INFLUENCE**

WEST VALLEY FOOTHILL PLANNING STUDY

EQUESTRIAN AND HIKING TRAILS

Figure 9: WEST VALLEY FOOTHILLS COMMUNITY PLAN



**DESIGN
STANDARDS** **6**

DESIGN STANDARDS

“ Provide an interconnected system of riding, bicycling and hiking trails which:

- Have safe access and travel to neighborhood , city, regional parks; recreational facilities, scenic areas, residential, commercial and industrial areas;

- Are aesthetically pleasing and create a “country and rural atmosphere” by integrating natural areas and urban areas with well planned linear open spaces.

All new development shall be developed in accordance with the Master Plan of Trails and adopted by City Design Standards.

Whenever possible, along Community Trails, street trees and landscaping should be included into the design adjoining the trails. The pallet of trees should conform to street tree standards but be low maintenance and drought tolerant.

Trails should be maintained on natural surfaces and located along natural, physical features whenever possible.

Non-residential development should consider use of amenities, for equestrian, pedestrian and bicycling activities such as hitching posts, benches, rest areas, drinking fountains and bike stands.”

– General Plan, p. III-63, 64

6.1 TRAIL WIDTH

Regional Trails generally follow the flood control channel and utility corridor rights-of way. Community trails may follow street rights-of way or other linear rights-of-way dedicated to the City. Local Feeder Trails are private easements within subdivisions. The right-of way width standards for trails shall be as follows:

TRAIL DESIGN WIDTHS

Regional Trails.....	30 feet
Community Trails.....	20 feet
Local Feeder Trails.....	15 feet
On-Street Bike Trails.....	5 feet
Off-Street Bike Trails.....	8 feet

Many trail routes will pass through land which is already developed, or has not been developed to its highest and best use, where space is limited. In such instances where topography, right-of way configuration, grading, improvements, or existing vegetation make it infeasible to construct full width trails as listed above, the Planning Commission may grant relief and reduce said requirements, upon recommendation of the Trails Advisory Committee.

6.2 HIKING AND RIDING TRAILS

NOTE: Every effort shall be taken to ensure that all hiking and riding trails are constructed to these standards; however, this may not be possible in certain situations due to physical constraints (i.e., existing bridges, utilities, existing rights-of-way, etc.) and in these cases, variation from these standards may be allowed subject to approval by the City Planner or Planning Commission, based upon review and recommendation by the Trails Advisory Committee.

Regional Multi-Purpose Trails and Community Trails should be designed to accommodate both equestrian users and the full range of pedestrian use, including hiking, running, jogging, and walking for pleasure. Local Feeder Trails are primarily intended for equestrian use, although they are commonly used by homeowners for morning and evening walks, and may also be used by children as a path to school. The following standards apply to Local, Community, and Regional hiking and riding trails, except where otherwise noted. These standards are illustrated in the Appendix.

A special mention is needed with regard to the Front Line Regional Trail: this trail should be left as natural as possible. Trail improvements to the Front Line Regional Trail should be minimal, limited to only those improvements necessary to provide a stable trail surface, and no fencing installed except where safety is a concern.

6.2.1 Vertical Grade: Steep grades are tiring for hikers and horsemen and create erosion problems. Long, gradual grades should be used rather than short, steep grades; switchbacks may be appropriate in some conditions. Acceptable grades are listed below.

- Optimum: 0-5%
- Maximum for distances over 500' : 10%
- Maximum for distances limited to 500' or less : 15%
- 20% permitted only in extreme cases and for short distances under 100' , and only in cases where no vehicle access is to be expected.

Steep areas may be handled by terracing steps, reinforced with wood. Steps can be negotiable by horses, but they must be broad, flat terraces, at least 3' deep as shown in detail below:

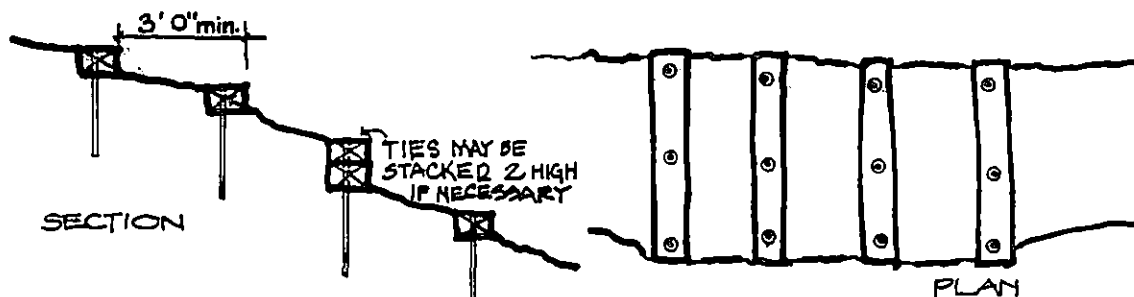

R.R. TIE TERRACE STEPS FOR HIKING & RIDING TRAILS

6.2.2 Cross Section Grade: Cross section grades should be kept to a minimum for safe travel. Grades of 2-4% are the optimum condition; 6% maximum may be used in approved locations subject to approval by the Trails Advisory Committee.

6.2.3 Tread Width: The minimum tread width (actual rideable surface) is 10 feet. This will allow two horses to pass each other with safety and ease.

6.2.4 **Sight Distances:** Adequate sight distances are required at intersections and drive approaches. The fence or wall line should end a minimum of 10' back from the B.C.R. in 20' trail easements. In smaller trail easements, determination should be made on an individual basis. Fence or wall line should end a minimum of 5' back from the top of the "X" at drive approaches.

6.2.5 **Clearance:** Vegetation should be preserved as much as possible to protect the aesthetic quality of the trail and prevent erosion. Vegetation should be cleared to a height of 10' 0" and to the minimum trail width. All new landscaping should comply with City standards for separation of utilities, sidewalks and fences, street lights, fire hydrants, etc., and as determined by the City Engineer.

6.2.6 **Drainage:** Drainage is an important consideration in trail construction. Surface water must be diverted from the trails surface before it builds up to an erosive force. The method used to drain the trail will depend on the quantity and velocity of water and the type of soils in the area. Where a trail gradient exceeds 4%, water bars, splash curbs, or other diversionary devices shall be required. Public Community Trails shall not be used to convey any runoff.

Where a downstream end of a Local Feeder Trail meets a public street, the trail shall be graded not more than 0.5% grade for a distance of 25 feet from the right-of-way line to prohibit trail debris from reaching the street. Appropriate drainage devices shall be installed to dewater this area to the satisfaction of the Building Official.

6.2.7 **Surfacing:** Surface shall be decomposed granite with a 4" minimum base. Subsurface preparation shall include removal of rocks and debris and grading the surface smooth. Regional Trail's shall include a redwood header between the asphalt concrete service road and the trail, and on the outside edge of the horse trail. A 6" wide concrete mow strip is required along both sides of the decomposed granite surfacing in Community Trails.

6.2.8 **Flood Control and Drainage Channel Crossings:** Where Community Trails cross drainage channels, the continuity of the trail shall be maintained by the construction of an appropriate crossing such as bridges, ramp ways, culverts, etc. Ideally, trail structures should be built using materials which blend into the environment, such as native fieldstone (not for surfacing) and wood. No metal surfaces shall be permitted, and bolt heads should be recessed, round-headed, or capped. Any structures within flood control right-of-way must adhere to San Bernardino County Flood Control District standards.

6.2.9 **Trail Entrance:** In addition to signing, it may be appropriate in certain situations to use barriers to prevent unwanted trail usage. On Community Trails, the entrance shall be designed to provide for equestrian, bicycling and hiking use and discourage motor vehicle access. All barricades must be recessed 15' back from the street entrance. A variety of barriers may be used for this purpose as shown in the City's trail standard drawings. Gates should be of galvanized steel and should not swing into the public right-of-way. Where there is no barrier, the entrance shall be posted (see Signing Standards). Local Feeder Trails shall provide for equestrian and pedestrian access and one means of unobstructed vehicular access for service access (e.g. - veterinarian).

6.2.10 **Street Crossings:** A trail should be designed with a minimum of street crossings for safety reasons. Warning trail users and motorists of crossings, with both pavement markings and signing, is necessary. Crossing shall be at grade on local streets or other streets with low traffic volumes and shall have appropriate signing. Where trails cross major streets, such as regional trails along flood control channels, the continuity of the trail shall be maintained by the construction of appropriate crossings such as, bridges, ramp ways, culverts, etc. For equestrian use, textured pavement, such as open graded asphalt, is required in the crossing in order to prevent horses from slipping. The concrete aprons shall be of a transverse medium broom finish.

6.2.11 **Fences:** Fencing is used all along trail routes to delineate the trail path, maintain the trail right-of-way, and to strengthen the image of the trail as part of the overall streetscape. Regional Trails are generally located along flood control channels with chain link fence installed by the Army Corps of Engineers at the channel right-of-way line and atop the concrete lined channel itself. The developer shall install a decorative masonry wall on the property line adjoining a Regional Trail. Community trails feature white, two rail PVC fence. Fence line should end 2' to either side of any fire hydrant and 1' to either side of any street light or utility pole. On 12' Community Parkway Trails, the fence shall have a minimum distance of 18" from face of curb. Local Feeder Trails shall, at a minimum, be built with lodgepole fencing to define the trail easement; homeowner or developer can upgrade to an alternate fence material.

6.2.12 **Gates:** Gated access should be provided to the rear of all lots within the Equestrian/Rural Overlay District and to any lot adjoining a trail where horse keeping is permitted. Gates may also be used to control access to trails by discouraging motorcycles and non-authorized vehicles.

6.2.13 **Lighting:** Lighting extends the hours that trails can be used, particularly in the winter months during the work week. Since most Community Trails follow the public street, the normal street lighting is sufficient. Paseo-type Community Trails which do not follow a street, and Regional Trails, should be provided with appropriate lighting for safety.

6.3 BICYCLE TRAILS

There are three types of bike trails commonly defined in California:

Class I Bike Path: A bike path is a special pathway designed for the exclusive use of bicycles, which is "off-street" and separated from motor vehicles by space or a physical barrier. A bike path may parallel a street or highway right-of-way or may be a special right-of-way, such as a flood control channel, it may be grade separated or have street crossings at designated locations. It is identified with guide signing and may also have pavement markings (See Figures 10 & 11).

Class II Bike Lane: A bike lane is a lane on the paved area of a road for preferential use by bicycles. It is usually located along the edge of pavement or between the parking lane and the first motor vehicle lane. It is identified by "Bike Lane" guide signing, special lane lines, and other pavement markings. Bicycles have exclusive use of a bike lane except for motor vehicle and pedestrian crossings (See Figure 12).

Class III Bike Route: A shared route is a street identified as a bicycle trail by "Bike Route" guide signing or pavement markings. The shared bike route has no barrier, either symbolic or physical, to delineate from the roadway for bicycles. Bicycle traffic shares the roadway with motor vehicles. The outside traffic lane becomes the width required for motor vehicle travel, usually 10 or 11 feet, plus the 4 or 5 foot bikeway (See Figure 13).

6.4 DESIGN STANDARDS FOR CLASS I BIKE PATHS

NOTE: It is intended that all bike trails conform to the standards contained in the Caltrans Highway Design Manual. Every effort shall also be taken to ensure that all types of bike trails are constructed to the standards listed below; however, this may not be possible in certain situations due to physical constraints (i.e., existing bridges, utilities, etc.) and in these cases, variation from these standards may be allowed subject to review and approval by the City Engineer.

6.4.1 **Design Speed:** 20 mph for level and undulating stretches, 30 mph for long downhill stretches.

6.4.2 **Maximum Grades:** the optimum vertical grade is 5% or less; 10 % is the maximum. The minimum cross section grade is 2% for drainage.

6.4.3 **Sight Distances:** The following sight distances shall apply:

SPEED	STOPPING DISTANCE
10 mph	50 feet
15 mph	80 feet
20 mph	120 feet
25 mph	150 feet
30 mph	200 feet

13

**Figure 10:
CLASS I BIKE PATH**

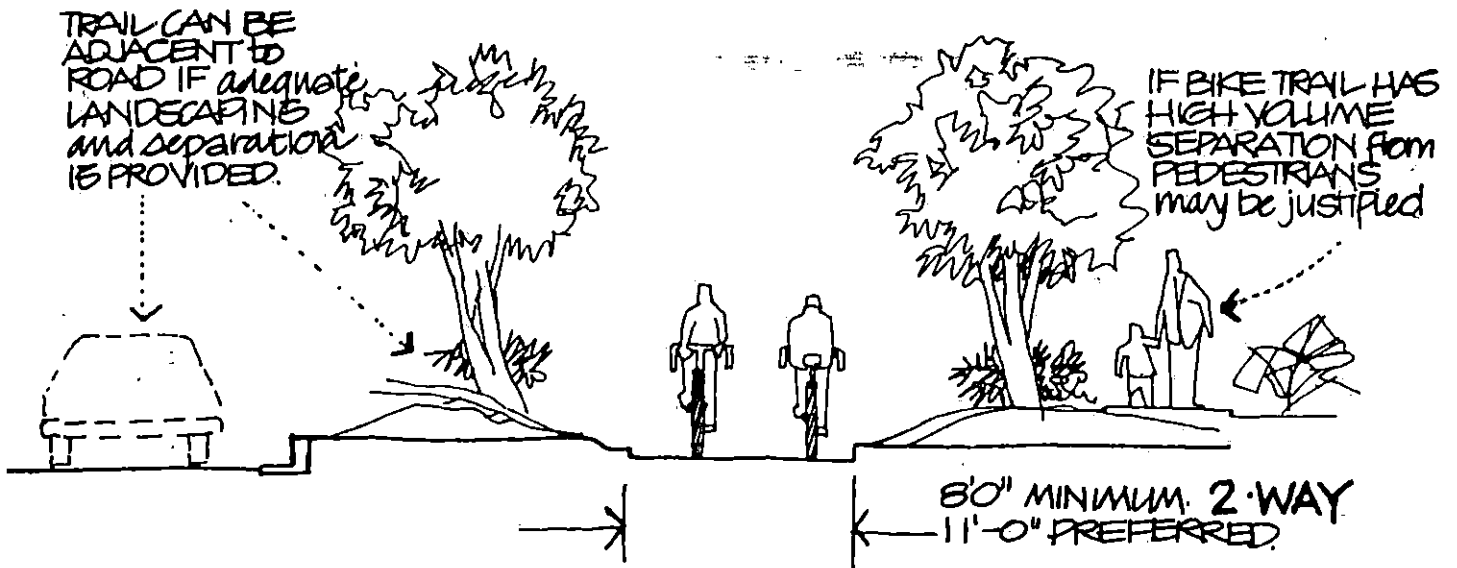

Figure 11:
CLASS I BIKE PATH ALTERNATIVE

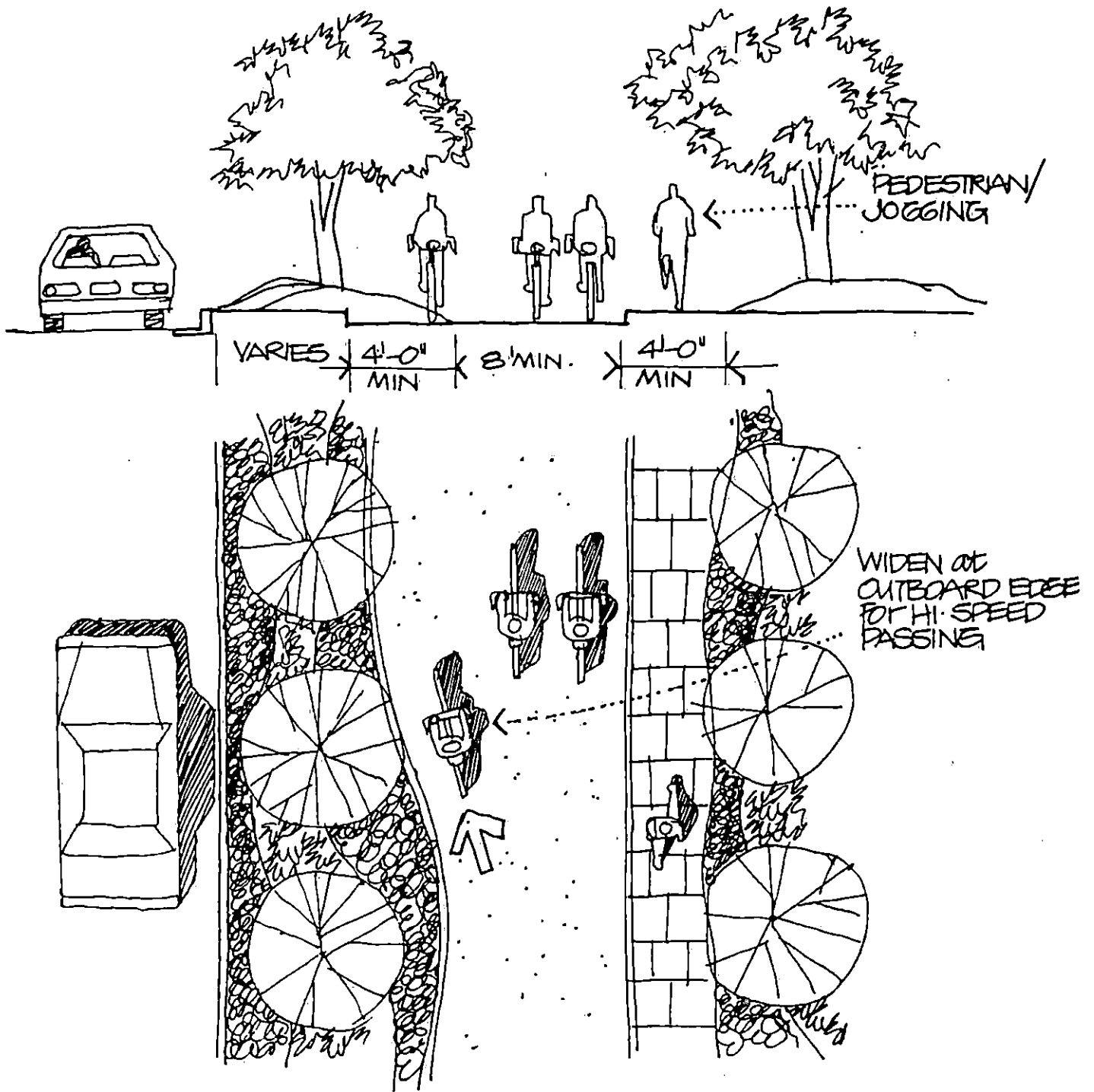
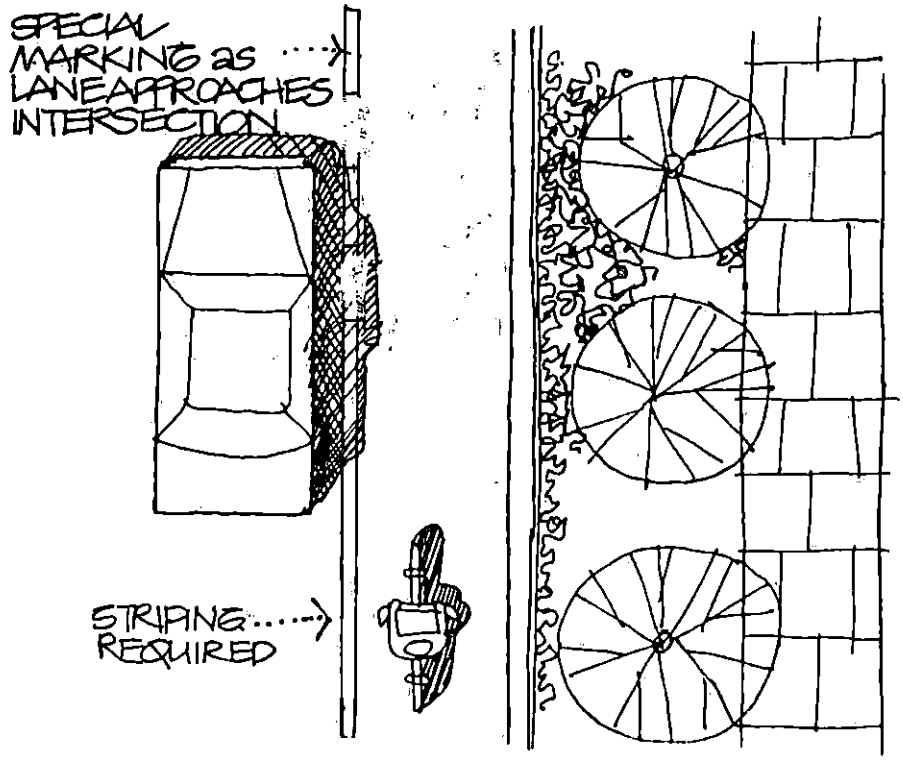
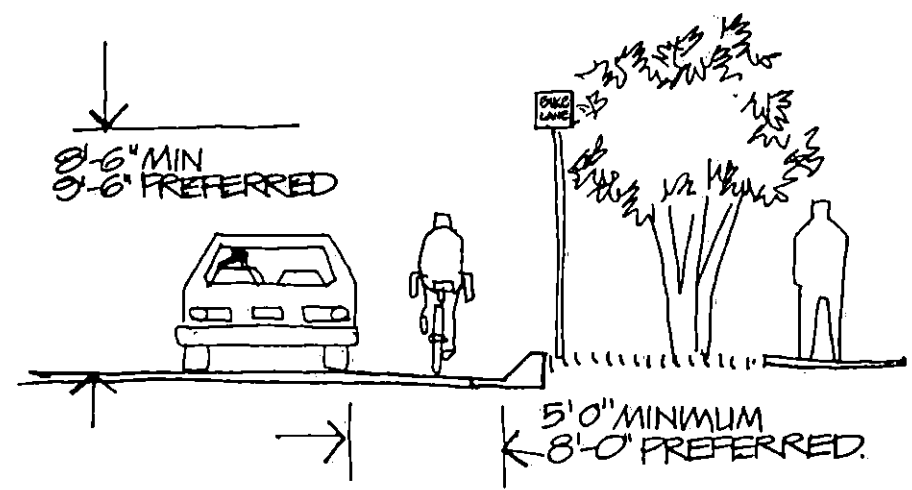
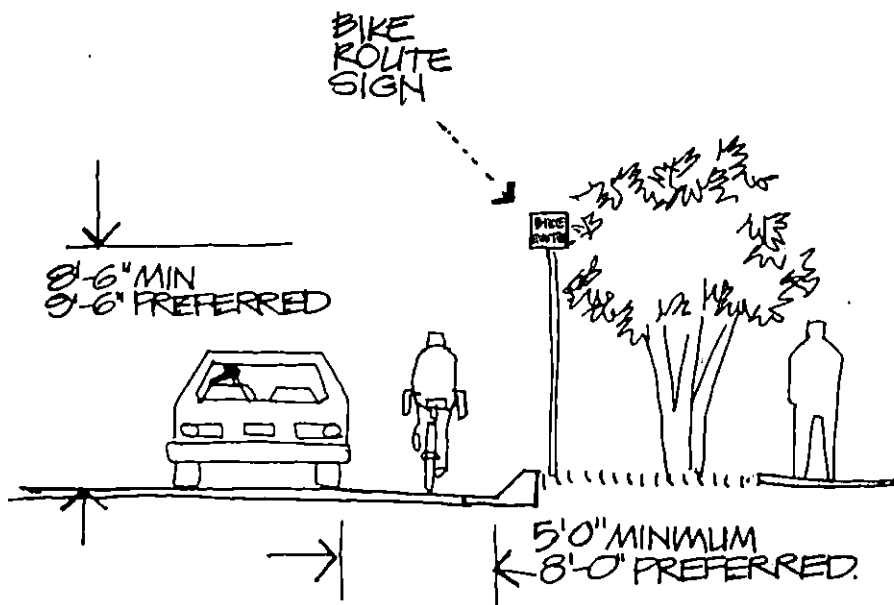

Figure 12: CLASS II BIKE LANE



**Figure 13:
CLASS III BIKE ROUTE**



6.4.4 **Curvature:** The following table shows the necessary design radius for various design speeds. No adjustments for superelevation are included; the minimum radius can be decreased approximately 2% for each 0.01 foot/foot increase in superelevation. A superelevation of 0.05 foot/foot is the generally recommended design value with 0.02 foot/foot the absolute minimum to allow for drainage.

DESIGN SPEED	MINIMUM RADIUS
15 mph	35 feet
20 mph	65 feet
25 mph	100 feet
30 mph	140 feet

Short, sharp curves should be avoided. For potential high-speed bike trails, such as bike paths and bike lanes, where bicyclists would enjoy relatively uninterrupted travel, curves with a radius of 100 feet or less should be widened about one to two feet to a maximum of four feet to allow for bicycle lean and greater maneuverability.

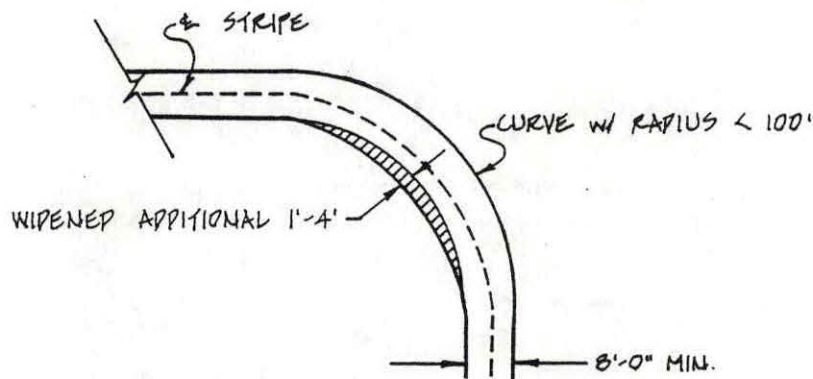

6.4.5 **Surfacing:** 3" asphaltic concrete over 4" aggregate base or 4" portland cement concrete.

6.4.6 **Drainage:** An asphalt surface requires a minimum cross slope of 0.02 foot/foot for proper drainage; concrete surface requires a minimum of 0.02 foot/foot. A banked bike path is preferred to a crown bike path because it is much simpler to construct uniformly. Ordinarily, surface run-off from the path will be dissipated if the shoulders have gentle slopes. However, when a bike path is constructed on the side of a hill or slope, a drainage ditch of suitable dimensions may be desirable on the uphill side to intercept the hillside drainage. In areas with a heavy surface or poor subgrade drainage, culverts, drain tiles, or catch basins are advised. However, certain drainage devices, such as, catch basins, storm drain inlets, and drain grates, present a major safety hazard to cyclists and should be kept out of the bike trail whenever possible.

6.4.7 **Clearance:** The minimum vertical clearance is 8.5 feet as shown below.

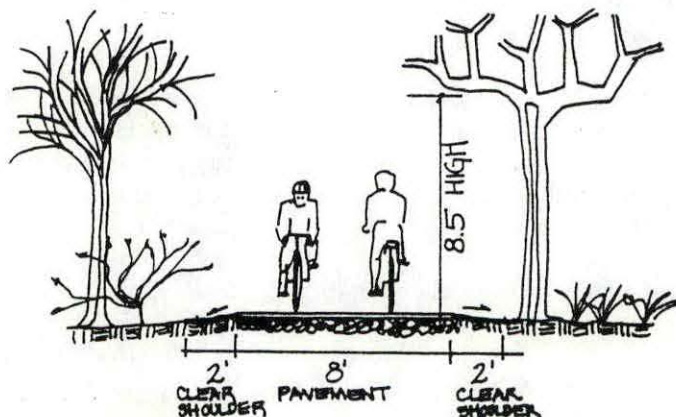

18

6.4.8 Barriers: Barriers or fences may be necessary on bike paths to separate cyclists from an adjacent hazard, or to prevent cars or motorcycles from entering the path. The barrier or fencing should be designed so that no posts or protrusions are on the cyclists side. Materials should be selected for their visibility, or painted, lighted, or otherwise highlighted to be visible by the cyclist. Barriers or fences should maintain the minimum dimensions shown below.

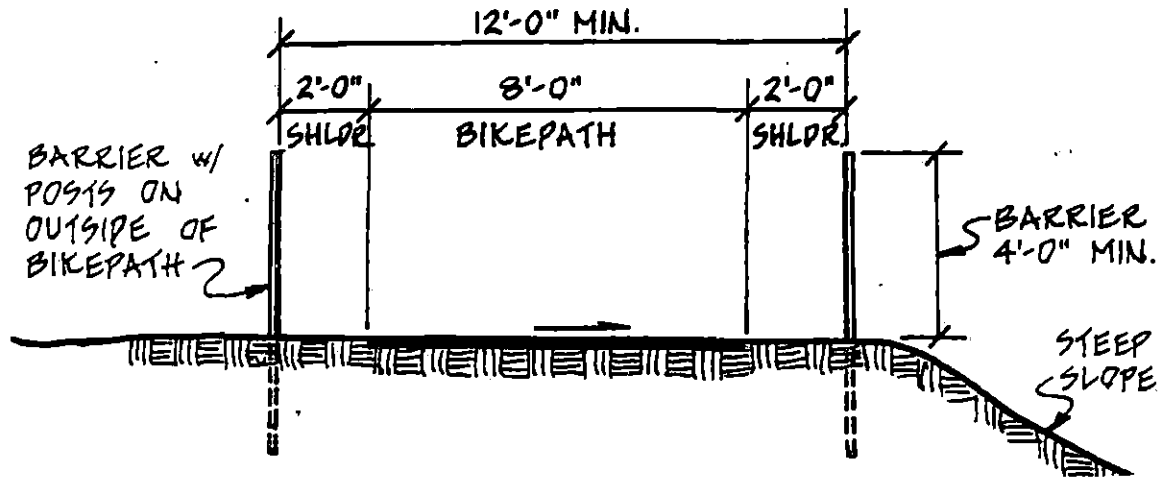

BIKE PATH BARRIER PLACEMENT

Bollards can be used to prevent cars or motorcycles from entering a bike path, as well as to slow cyclists down when approaching an intersection. Bollards should be installed as shown below.

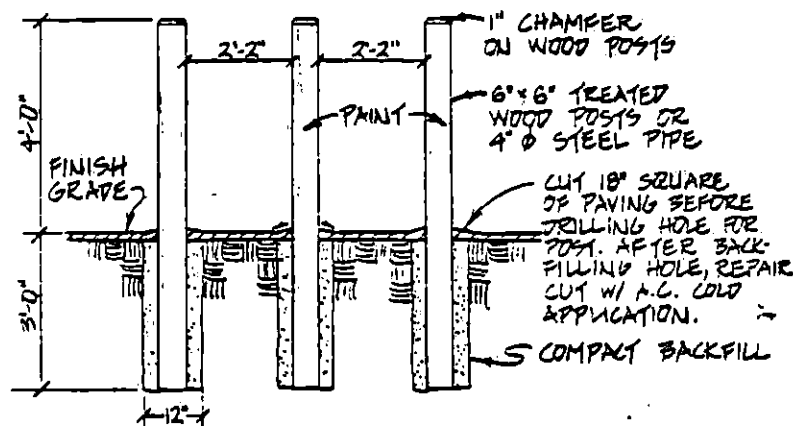

6.4.9 Bridges: At stream or drainage channel crossings, a bridge should be at least 12 feet wide with railings 4 feet high, and should be strong enough to support a service vehicle. Where service access across the bridge is not required, the bridge may be 8 feet wide.

6.4.10 Intersections: When on-grade crossings are unavoidable, it is desirable to locate the bike path to take advantage of traffic lights. If neither a traffic light nor a separated grade crossing is possible, the intersection should be carefully marked for both motorists and cyclists. Crossing locations should be chosen to provide adequate sight distances for both trail users and motorists. All intersection designs and crossings must be designed to the satisfaction of the City Engineer.

6.4.11 Bike Path Delineation: A 4-inch wide, white edgestripe should be provided to help guide cyclists at night, whether or not path lighting is provided. A 4-inch wide, yellow center line should be used at sharp curves, narrow undercrossings, or locations where sight distance is restricted. "BIKE PATH" pavement markings or the use of the bicycle symbols are required at a maximum 1/8 mile apart, primarily at trail entrances.

6.4.12 Street Crossings: Where bike trails must cross major streets with moderate to high traffic volumes, appropriate crossings, such as bridges, rampways (underpasses), or culverts should be constructed to maintain the continuity of the trail system.

6.4.13 Lighting: Class I bike trails will be used by both the casual bicycle rider and the bicycle commuter. Hence, lighting offers two important benefits: 1) extends the riding hours for bicyclists, and 2) promotes safety by providing greater visibility for the cyclist. Therefore, lighting should be provided for Class I bike trails. The master planned communities of Terra Vista and Victoria provide examples of appropriate lighting for bike trails.

6.5 DESIGN STANDARDS FOR CLASS II AND CLASS III BIKE TRAILS

Bicyclists can be accommodated effectively on roadways with advance planning. Many existing scenic roads, with low to moderate traffic volumes and speeds, provide excellent recreational cycling. Other factors determining choice and design of on-street bike trails are: truck traffic volume, accident experience, existence of bus routes and stops, pavement width and right-of way availability, scenic qualities, abutting land use, grade profile, and user characteristics. The City's General Plan policies encourage alternative transportation modes, such as commuting by bicycle; therefore, bike trails are needed to link residential areas with areas of commerce and industry.

6.5.1 Design Speed: Generally, streets are designed for higher speeds than a bicyclist travels, so most streets are suitable for bicycles.

6.5.2 Maximum Grades: Choose streets with grades of less than 10%. Where this is not possible, choose routes with the most gradual slopes.

6.5.3 Curvature: Streets are generally designed for higher speeds and larger turning radii than are required for bicycles. In certain situations, it may be advisable to widen a curve one to two feet for greater maneuverability.

6.5.4 Surfacing: A smooth surface is essential for bicycling and existing road pavements are usually adequate for bicycles. However, a pavement management and street sweeping program should address repaving rough sections, patching holes, and keeping the shoulder clean and stable. A good standard is that any holes, cracks, etc., more than one inch deep should be repaired. If a roadway is widened, the added paving should conform to standards for the type of roadway involved and should be paved the full width of the traffic lane and shoulder to avoid uneven seams and cracks.

6.5.5 Surface Drainage: Low spots, which collect water and debris, and any other situation with poor drainage, should be corrected. Precautions must be taken to assure that drainage structures do not obstruct the path of bicyclists. Grate structures that consist of bars running parallel to the curb can easily entrap a bike wheel and cause a serious accident. A number of acceptable designs are available which allow bicyclists to cross safely, including grates with bars perpendicular to the curb and zig-zagging bar grates.

6.5.6 Minimum Width: Class II Bike trails consist of delineating a separate lane on a street for bicyclists. The minimum width should conform to the *Caltrans Highway Design Manual*, which is typically 4 or 5 feet.

6.5.7 Clearance: The minimum vertical clearance is 8.5 feet. Vegetation should be removed within this area and street furniture, such as lamp posts, designed accordingly.

6.5.8 Barriers and Fences: Where a bike route is on a roadway crossing a bridge, or above a steep slope, a barrier may be necessary. Standard highway guard rails are not high enough to provide safety for the cyclist and ideally should be replaced or supplemented with a higher safety fence at least 4'0" when other work is performed on the bridge.

6.5.9 Bridges: If a bridge exists on a roadway designated as a bike route or lane, it should be wide enough to

accommodate both automobiles and bicycles. Lane widths should conform to Section 6.5.6; however, if the bridge is not wide enough, widening to provide a uniform width along the entire route should be considered. A physical separation, such as a 4-foot chain link fence, positive barrier, or island is required to offset the adverse effects of having adjacent bicycles and motor vehicles traveling in opposite directions to one another.

6.5.10 Intersections: Bike trails through intersections should be designed for all types of bicyclists, accommodating "beach cruisers" whose riding style is similar to pedestrians, and serious recreational cyclists whose actions are similar to motorists.

Class II and Class III bike trails should be routed along roads with the safest intersections, whenever possible. Traffic engineers should be consulted to redesign hazardous intersections.

6.5.11 Bike Trail Delineation: Bike trail striping and markings shall conform to the *Caltrans Highway Design Manual*.

6.5.12 Signals: New or modified traffic signals shall be equipped with conveniently located curb side buttons.

6.5.13 Lighting: Like Class I bike trails, lighting is recommended for bike lanes and bike routes. Fortunately, the normal street lighting will usually suffice.

6.6 TRAIL SIGNING

Signing is required to let the user and the public know where trails are. Signs may be used to designate a "trailhead" or starting point, provide directional and destination information, provide warning or regulatory information, and provide general information for the trail user.

The following guidelines give examples of signs which may be used on trails; however, each signing situation should be evaluated individually.

6.6.1 Materials: The criteria for material selection are: durability, ease of maintenance, aesthetics, and compatibility with the natural environment. Wood, concrete, and metal are typical materials that may be used singularly or in combination. A simple, yet attractive, method of marking a trail route is the use of rustic redwood 4"x4" posts, with routed letters or symbols. Wood is economical to manufacture; however, concrete or metal signs may be appropriate where vandalism is a concern. Metal is appropriate where standard highway signs are used.

6.6.2 Colors: Wooden signs are normally brown with white lettering. Other earth tones may be used; however, there must be enough contrast between the background and the letters for the sign to be legible. Highway sign colors are set in the *Manual on Uniform Traffic Control Devices (MUTCD)* and may also be copied for trail signing. In standard highway signing, red is used for stop signs and prohibitions; yellow is for warning; green, movement permitted, directional guidance; blue, services; black and white, regulation; orange, construction; and yellow, maintenance warning.

6.6.3 Size: Highway sign sizes are standardized (refer to MUTCD).

6.6.4 Location: Signs should be located so as to be easily read by the trail user. Signs used to warn motorists should be easily read from the roadway and to provide stopping distance. On bicycle trails, signing should be placed to provide safe stopping and turning distances (see *Bicycle Trail Design Standards: Sight Distance*).

On paved bicycle trails, sign messages may be painted onto the pavement, rather than or in addition to, a sign on a post. On bicycle lanes or routes on a street, signs should be placed back of the shoulder, providing at least a two-foot clear shoulder adjacent to the trail. Signing should be consolidated whenever possible; it is preferable to have one sign with three messages than three signs with one message each. However, warning or regulatory signs should not be mixed with other types.

Highway signing location and heights are standardized and can be found in the MUTCD and the *Caltrans*

6.6.5 Trail Head Signs: These signs may be placed at all riding and hiking trailheads and should include the following information: name of trail (if one exists), a location map of the trail and vicinity, destinations, distances, types of uses allowed, and other information. A standard format is shown below.

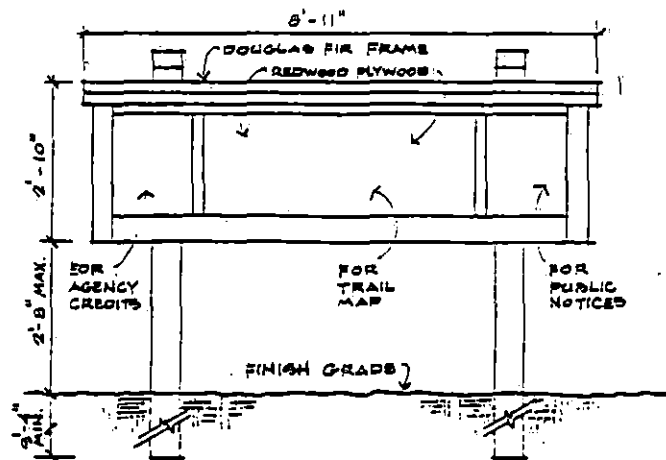

6.6.6 Directional Signs: Directional Signs should be used at intersections with roads or other trails, where paths could be confused. Avoid using too many directional signs. On riding and hiking trails, the standard directional sign is a 4"x4" redwood post with arrows and other information routed as shown below.



D11-1
24" x 18"
24" x 6"



14
24" x 24"
24" x 6"

See also the M.U.T.C.D. for instructions on placement and use.

The other two directional signs shown above are to be used on roadways; one is the standard Bike Route sign, which has the word "Regional" or "Community" added and a directional arrow; the other is a trail sign which could be used when a trail crosses a roadway.

6.6.7 Destination Signs: These signs will be placed at appropriate locations to inform trail users of the distance and/or destinations of various routes. These signs should include directional arrows where confusion with other trail routes is possible.

On-street bike routes may have a strip added below the standard Bike Route sign, saying "To...", or a separate

sign with more than one destination . Distances on destination signs should be given in miles and kilometers.

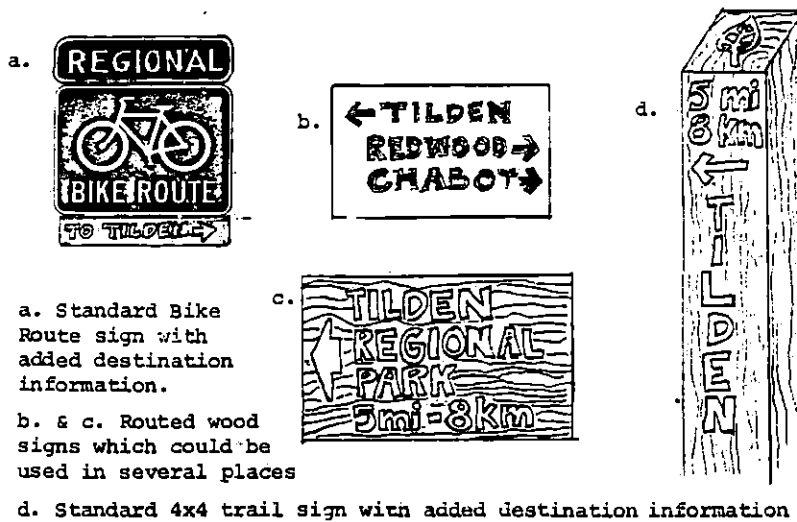

6.6.8 Warning Signs: Warning signs are required on trails to warn trail users of hazardous conditions on the trail, and to warn both trail users and motorists of locations where a trail crosses a roadway. Signing on trails should be placed far enough in advance of the hazard that the user has time to slow down and maneuver, particularly on bicycle trails.

Sight distances for stopping at various speeds are given in the "Bicycle Trails Design Standards" section. Generally, bike trails should be designed for 20 mph speeds, which means that the warning signs should be 120 feet ahead of the hazard. On paved bicycle trails, warnings should be painted on the pavement, as well as signed. Following are typical warning sign examples:

TYPICAL WARNING SIGNS FOR TRAIL ROADWAY CROSSINGS



W3-1.



W3-2

30"x30" is standard size of these signs to be used on roadways; a 15"x15" size can be used on bike trails.



W11-1



W11-2

To be used on roadways to warn motorists of trail crossing. "Horse Crossing" logo also available.

TYPICAL WARNING MARKINGS FOR BIKE PATHS

May be used alone or in conjunction with signing.

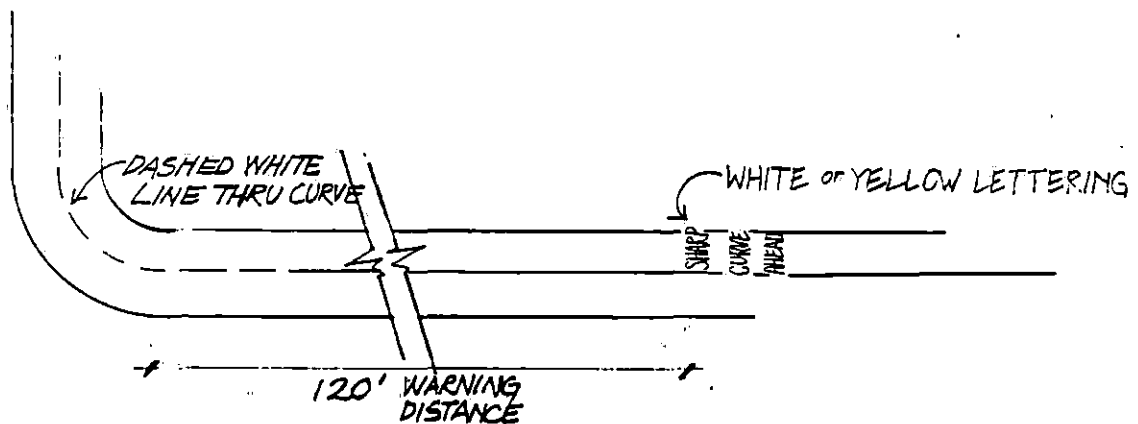

6.6.9 Regulatory Signs: STOP and YIELD signs are the most commonly used regulatory signs. Other regulatory signs which may be used on trails include prohibitions such as "No Dogs", "No Smoking", and "No Parking".



R1-1

24"x24" or
18"x18"

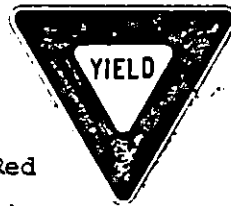

Red
White

R1-2

36"x36"x36" or
18"x18"x18"

For roadway or trail use.

6.6.10 Information Signs: This type of sign may be used as mileage markers or may point out the location of water, telephone, emergency services, rest areas, etc.

6.6.11 Intersection Signs: Where trails cross roadways, warnings for both the trail users and motorists should be evaluated individually. Signing for motorists is set forth in the MUTCD; scaled down versions of the motorist signs may also be used on trails. Diagrams of typical crossings are shown in Figure 14. Painted crosswalks at uncontrolled intersections must be evaluated on a case by case basis.

Figure 14: BIKE TRAIL INTERSECTION SIGNS

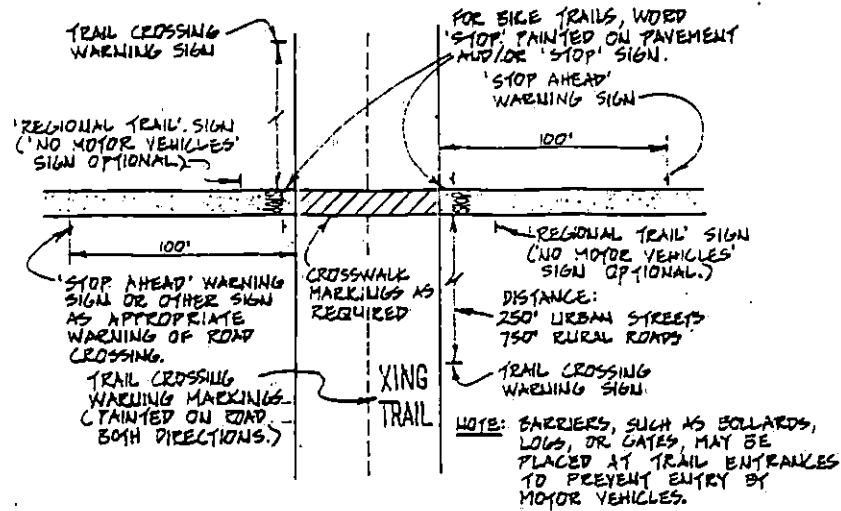

TYPICAL SIGNING - TRAIL CROSSING AT MID-BLOCK

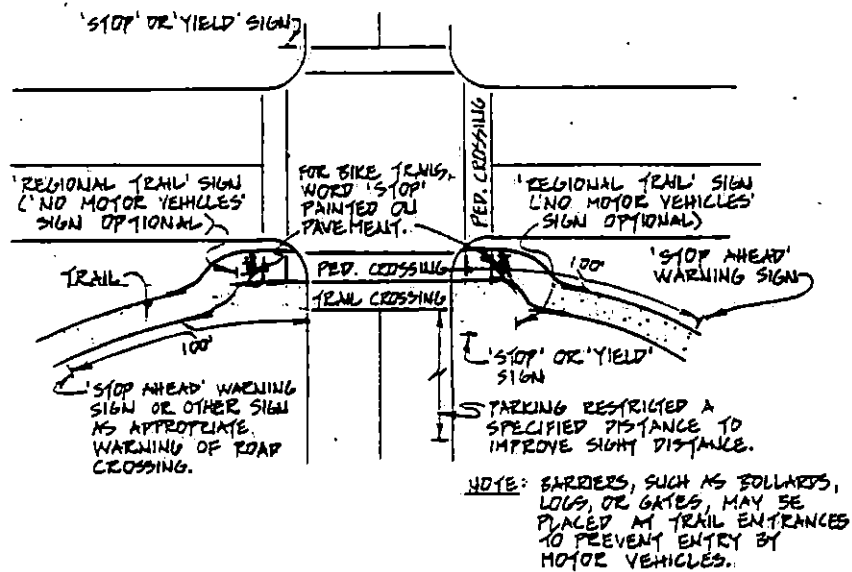

TYPICAL SIGNING - TRAIL CROSSING AT INTERSECTION

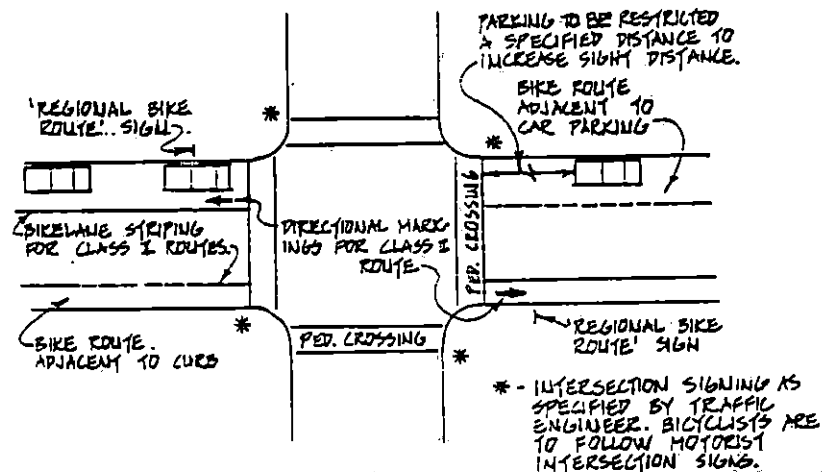

TYPICAL SIGNING - ON STREET BIKE ROUTE CROSSING

ADMINISTRATION 7

ADMINISTRATION

"A key element of the overall open space/recreational network is the linkage between recreational facilities. The primary means of achieving this linkage is through an integrated citywide trail system. The means to implementing this system are two-fold. First, the City shall exercise its authority under Section 66474 of the Government Code to insure that proposed subdivision maps are consistent with the multi-use trails system shown in Figure III - 5. Trails provided by subdivisions may be used to satisfy park and recreation facility dedication requirements in accordance with the sliding scale shown earlier. Secondly, where the City does not have jurisdiction, it must work closely with the County's Regional Park Department, San Bernardino County Flood Control District and the U.S. Army Corps of Engineers, especially to maximize trail development along flood control channels and through flood control lands. Unless maintenance responsibility is assumed by some other public agency or special district, the City shall assume maintenance responsibility for the multi-use trail system."

— General Plan, p. III-72

7.1 RESPONSIBILITY

The implementation of the trail system envisioned by the City's General Plan will require the coordinated efforts of many City departments and other public and private agencies. Implementation involves planning, acquisition of land, design, construction, and maintenance. In addition, an implementation program must address procedures for handling complaints, enforcement, and abandonment. Therefore, many City departments must be involved in the process of implementing trails.

Due to the complexity and scope of implementing the City's Master Plan of Trails, the City should consider creating a Trails Coordinator position. Primarily, this position would be responsible for coordinating trail issues among the various departments, seeking grant funds for trail development projects, working with the Trails Advisory Committee, negotiating agreements with the County Flood Control District and utilities for trail use rights within flood channel or utility corridors, and negotiating for trail acquisition with private property owners. A recommended job description is included in the Appendix.

The matrix in Figure 15 gives an overview of the responsibility of each department which is discussed in more detail in the following sections.

7.1.1 Local Feeder Trails: Local Feeder Trails are required as a condition of approval on tract maps; hence, they are installed by the developer as part of the subdivision improvements. These trails are private easements maintained by the individual property owner. Typically they are enforced by the property owners through provisions in private deed restrictions established in the Conditions, Covenants and Restrictions for the tract.

7.1.2 Community Trails: In undeveloped areas, Community Trails would normally be installed by a developer as a condition of development. Upon acceptance of the trails as part of the tracts public improvements, the City would be responsible for maintenance and enforcement. In rare instances, the City may construct a Community Trail on vacant land to provide vital linkage in the overall system. In existing developed areas, the City would retrofit the Community Trail and maintain them as part of the parkway maintenance program.

7.1.3 Regional Trails: Regional Trails are primarily installed along flood control and utility corridors. The San Bernardino County Flood Control District installs a paved service road on at least one side of the channel which becomes the hiking and bicycling trail path. The City must construct the horse riding trail path. Trail amenities such as landscaping, signs, and access control gates/barriers are generally installed by the City. Existing joint use agreements with the County Flood Control District require the City to maintain the trails.

**Figure 15:
TRAILS RESPONSIBILITY**

AREAS OF RESPONSIBILITY FOR TRAILS			
P=PRINCIPAL S=SUPPORTING			
TRAIL TYPE	BUILDING & SAFETY	ENGINEERING	PLANNING
LOCAL FEEDER			
1. ACQUISITION		S	P
2. IMPROVEMENT	S(3)		P
3. MAINTENANCE	S(1)		P(3)
4. ENFORCEMENT	S(1)		P
COMMUNITY			
1. ACQUISITION			
A. UNDEVELOPED AREAS		S	P
B. DEVELOPED AREAS		P	P
2. IMPROVEMENT		P	S
3. MAINTENANCE	S(1)	P	S
4. ENFORCEMENT	S(1)	S	P
REGIONAL			
1. ACQUISITION			
A. UNDEVELOPED AREAS		S	P
B. DEVELOPED AREAS		S	P
2. IMPROVEMENT		P(2)	S
3. MAINTENANCE		P	
4. ENFORCEMENT		S(2)	P
1. GRADING/EROSION PROBLEMS 2. COORDINATE WITH S.B.C.F.C.D. AND ARMY CORPS OF ENGINEERS 3. DEVELOPER OR PRIVATE PROPERTY OWNER			

The Engineering Division has the principal role in preparing a capital improvement program for trails as part of the annual budgetary process. The Planning Commission provides priority recommendations for trail projects to assist staff in preparing the budget. The City Council authorizes specific trail improvement projects as part of the overall approval of the City's budget.

7.2 TRAIL ALIGNMENT

The Planning Division has the principal role in the review and selection of proposed trail routes. The Planning Commission oversees this role and provides direction to staff. The Trails Advisory Committee is appointed by the Commission to advise them on trail matters. The Planning Division serves as the staff to both bodies. General trail alignments are established in the City's *Master Plan of Trails* contained in the General Plan. More precise alignments are indicated on Figures 2 and 7 of this document.

7.3 ACQUISITION

This section addresses responsibility for acquisition of trail rights-of-way. A more complete discussion of acquisition methods is contained in Chapter 8.

7.3.1 Local Feeder Trails: The Planning Division is responsible to ensure that appropriate easements are established at the time of subdivision or development review approval. The staff rely upon the expertise of the Trails Advisory Committee in this task. The Planning Commission oversees the review process and is the final approval body.

7.3.2 Community Trails: Within undeveloped areas, the Planning Division coordinates the subdivision review process and will ensure that dedication is acquired at the time of development approval. Where it is necessary to acquire trails through developed neighborhoods, the Planning and Engineering Divisions will jointly negotiate with private landowners for trail rights-of-way. The Planning Division will have the supportive role in identifying these necessary trail linkages and the Engineering Division will have the supporting role in the preparation of the necessary documents.

7.3.3 Regional Trails: The Planning Division negotiates agreements with the San Bernardino County Flood Control District for public access to flood control land for Regional Trail purposes, and with public and private utilities for use of utility corridors for trails. The Engineering Division provides assistance as needed.

7.4 DESIGN

The Planning Division has the primary responsibility for designing Local Feeder Trails. The Engineering Division has primary responsibility for preparing construction design documents for Community and Regional Trails, with assistance of the Planning Division and recommendations of the Trails Advisory Committee. The Engineering Division provides information and assistance in matters of public improvement standards and other engineering matters. The Building and Safety Division provides support in the area of grading. The developer is responsible for preparing trail improvement plans consistent with City Standards as required by the conditions of approval for his project.

7.5 PLAN CHECK COORDINATION

7.5.1 Local Feeder Trails: The Building and Safety Division has the primary role in receiving and distributing grading plans for review by Planning and Engineering. The grading plans should include trail improvements. The Planning Division should review plans to ensure proper trail alignments and compliance with conditions of approval and City standards. The Engineering Division reviews grading plans regarding how trails may effect public improvements (i.e. streets). The Building and Safety Division reviews grading plans to insure that trails are graded and drain properly per City standards.

7.5.2 Community Trails: The Community Trails must be shown on the final tract map and on separate public improvement plans to the satisfaction of the City Engineer. The Engineering Division has the primary role of receiving and distributing plans for review by Planning. The Planning Division is supportive in providing information regarding trail alignment, design standards, barriers, landscaping and signing.

7.5.3 Regional Trails: The Engineering Division has the principal role in preparing trail improvement plans for retrofitting trails along flood control and utility corridors. Engineering also has primary responsibility for reviewing trail plans proposed by other public and private agencies. The Planning Division provides assistance regarding design standards, barriers, gates, landscaping and signing.

7.6 CONSTRUCTION AND INSPECTION

7.6.1 Local Feeder Trails: These trails are installed by the developer. The Building and Safety Division inspects Local Feeder Trails for conformance with the approved grading plans. The Planning Division inspects Local Feeder Trails for conformance with approved alignments, fencing, and provides assistance, particularly to resolve field changes and to clarify design standards.

7.6.2 Community Trails: In undeveloped areas, the developer installs the trails as part of the public improvements. Where Community Trails are being retrofitted into existing neighborhoods, the trails are constructed by City contractors as part of the Capital Improvement Program authorized by the City Council. Minor trail projects and trail repairs may be constructed by City Maintenance Department crews. The Engineering Division has the primary responsibility for inspecting Community Trails to ensure conformance with public improvement plans as approved by the City Engineer. The Planning Division provides information and assistance in matters of design standards and resolving field changes.

7.6.3 Regional Trails: The City will install all or a part of the trails along the flood control channels. The City's Engineering Division coordinates contracts for the installation of trail improvements. The Engineering Division oversees the inspection of Regional Trails being installed under City contract with assistance from the Planning Division as needed.

7.7 MAINTENANCE

7.7.1 Local Feeder Trails: The City has, and will continue to have, Ordinances requiring proper maintenance of Local Feeder Trails for user safety and functionality. The property owner maintains his section of the private Local Feeder Trail easement. In some instances, maintenance is the responsibility of a Homeowners Association as may be established in the subdivision deed restrictions. In addition, the City presently contracts with the Weed Abatement Division of the County Agricultural Department for weed abatement services. A recommended Ordinance is included in the Appendix that would establish more definitive trail maintenance standards.

7.7.2 Community Trails: Engineering's Maintenance Department has the principal role in maintaining the public Community Trail System, including on-street bicycle trails. In most instances, a Landscape Maintenance District has been formed for the purpose of generating funding and maintenance of trails.

7.7.3 Regional Trails: Engineering's Maintenance Department typically maintains Regional Trails under the terms of the joint agreements with the County Flood Control District and other public or private utility companies.

7.7.4 Hiking and Riding Trail Maintenance Standards: The following minimum standards shall apply:

A. Inspect trails, bridges, fencing, gates, vehicle barriers, lighting, and signs at regular interval for safety hazards, damage, or other needed maintenance or repairs.

B. Continuously maintain proper grade and surfacing of all trails, including, but not limited to, removal of loose rock in excess of 1" diameter, filling pot holes, and refilling with new surfacing material to required depth, as needed.

C. Vegetation should be kept cleared to a height of 10'0", to the minimum trail width, and to maintain adequate sight distances.

D. Maintain regular weed abatement program to keep trail surface free of weeds.

E. Use of chemicals should be avoided, whenever possible, because of potential ingestion by horses.

F. Replace stolen, damaged, or obsolete signs.

7.7.5 Bicycle Trail Maintenance Standards: The following minimum standards shall apply:

A. On bicycle trails, repave rough sections, repair broken or damaged pavement, and patch holes or cracks greater than one inch deep.

B. Maintain regular sweeping program to keep the trail surface free of loose sand and gravel, broken glass, and other litter.

C. Inspect trails, bridges, fencing, gates, vehicle barriers, lighting, and signs at regular interval for safety hazards, damage or other needed maintenance or repairs.

D. Vegetation should be kept cleared to a height of 8'6" and to maintain adequate sight distances.

E. Replace stolen, damaged, or obsolete signs.

7.8 ENFORCEMENT

In general, all complaints regarding trails should be handled by the City department responsible for that aspect of the trail covered by the complaint, as described above.

7.8.1 Local Feeder Trails: These are private easements and the enforcement of maintenance or use is enforced by the property owner through the provisions of their Conditions, Covenants, and Restrictions (CC&R's). The extent of use of these easements is limited by the expressed terms and purposes set forth at the time of its creation. Typically, the CC&R's limit use of the easement to equestrian purposes and may specifically prohibit their use for "non-equestrian" uses such as, vehicles or motorcycles. Pursuant to City's General Plan provisions, Local Feeder Trails are intended to provide the user with access from their residential lot to the Community or Regional trail system. In short, these private easements are only for the use by property owners within the given subdivision and the unauthorized use by nonresidents could constitute a trespass to property.

At present, a number of developments in the City contain CC&R's which provide for enforcement by City action. However, despite the purported authority of these enforcement provisions, the City lacks valid authority to enforce private CC&R provisions. All CC&R's are enforceable in a court of law as a binding property restriction on individual property owners based upon the theory of "equitable servitude." The courts have stated that a person seeking to enforce CC&R's must have an "interest" in the property subject to the CC&R's. As a non-property owner, the City lacks this requisite interest to enforce private CC&R provisions.

There have been several instances where a property owner has modified a Local Feeder trail such as, erecting a fence across the trail or changing the grading. The City has authority to enforce actions of a property owner which are contrary to the conditions of approval which required said trail. Each tentative tract bears a condition requiring that trails be installed in accordance with the equestrian trail plan of the particular development and City standards. Like with any other violation of a specific condition of development approval, a property owner who changes the Local Feeder trail from that plan approved for the development should be susceptible to an injunction action by the City.

The final issue with respect to Local Feeder trails is the potential for property owners to attempt to eliminate said

trail easements without City approval. Since, as mentioned above, Local Feeder trails are an express condition of tentative tract map approval and installed pursuant to a detailed equestrian trail plan for the development, any attempt to vacate the trail easement by either a property owner or homeowner association would constitute a violation of the condition of approval and would render the action susceptible to injunction by the City. The correct procedure to consider abandonment of a Local Feeder trail easement is described below.

The City should establish enforceable maintenance standards for Local Feeder Trails whereupon the City would become involved in handling complaints. A recommended ordinance is included in the Appendix. The Planning Division Code Enforcement Section would have primary responsibility for handling complaints regarding Local Feeder Trails. Complaints dealing with weeds will continue to be forwarded to the County Agriculture Department's Weed Abatement Division. Grading or erosion complaints would be the responsibility of the City's Building and Safety Division.

7.8.2 Community Trails: The Planning Division has the principal role in enforcing use problems that may occur on Community Trails. Maintenance problems, such as weed abatement, erosion or removing obstacles would be handled by the Engineering Maintenance Division. The Sheriff's Department may also respond to complaints regarding illegal use or activity on Community Trails, such as motorcycles. Grading or erosion problems on private property that adversely impact the Community Trail would be the responsibility of Building and Safety Division.

7.8.3 Regional Trails: The Regional Trails are located on land owned or easements controlled by other public and private agencies. Use of these lands for trails is governed by the terms and conditions of joint-use agreements. The City's Engineering Maintenance Division would be responsible for maintaining the trail and trail appurtenances.

7.9 TRAIL ABANDONMENT

Inquiries and petitions to abandon Local Feeder Trails are the principal responsibility of the Planning Division. Since the trail easement is part of the recorded final map, vacation would require the approval of 100 percent of the property owners within the tract. Upon receipt of such a request, the Planning Division would prepare a report to the Trails Advisory Committee. The Planning Commission would then conduct a hearing to consider the request to amend the tract map to vacate the trail easement based upon the recommendation of the Trails Advisory Committee. The petitioners would then prepare, at their expense, an amended tract map deleting the trail easement. The amended map, together with the recommendation of the Planning Commission, would be forwarded to the City Council for final action.

IMPLEMENTATION 8

IMPLEMENTATION

"That the area shown in the Equestrian/Rural designated area provided for:

- The keeping and protection of animals on private property, including equine, bovine, cleft-hoofed animals, and poultry.*
- Require that all development within the area relate to existing and future areas occupied by equine, bovine, left-hoofed animals, and poultry by providing trail connections through easements in order to connect disconnected trails and for needed access to recreation activities.*
- That all trail easement shall be maintained through an active program of weed abatement in a neat and orderly manner on all developments.*

The City shall facilitate the development of a Regional Multi-Purpose Trail System as shown on Figure III-7. All segments of the Regional Multi-Purpose Trail System, shall be available for use as equestrian, pedestrian and bike trails where feasible.

The City shall establish an agreement with San Bernardino County for the use and maintenance of the flood control rights-of-way for the trails.

The City shall establish an agreement with public and private utilities for the use and maintenance of utility corridors and rights-of-way for the trails.

The City shall consider a program for the maintenance, and where necessary, construction and rehabilitation, of Community Trails."

— General Plan, p. III-63

8.1 REGULATORY PROCEDURES

The City exercises its police power authority to ensure that subdivision maps and other development projects are consistent with the General Plan's *Master Plan of Trails* and related trail policies. The City's Development Code require that all subdivisions within the Equestrian/Rural Overlay District provide Regional and Community Trails in accordance with the *Master Plan of Trails*, and provide Local Feeder trail access to the rear of each lot. Further, the Code requires that even non-residential projects provide trail easements where it is determined that such trail connections are necessary. Refer to the City's Development Code for an explanation of the review process.

8.2 SOURCES OF FUNDING

Commonly, the most difficult aspect of implementing a plan is the acquisition of adequate funding. Funds and community support for the required funding sources are an essential component of any successful program. Summarized below are some of the current and potential methods of financing trail improvements. The purpose of this section is to list all potential funding sources; however, some may not be considered as viable financing tools as noted herein and in the *Trails Financing Plan* in the Appendix. The present City Council does not support the use of new assessments or fees to finance trails. Therefore, the Plan places greater emphasis on completing the trail system as development occurs and using other revenue sources, such as grants.

8.2.1 Tax Base: Some support for trail acquisition, development, and maintenance comes from the City's General Fund. Unfortunately, Rancho Cucamonga is one of three "zero tax base" cities in the State of California as a result

of Proposition 13. Therefore, General Fund priority for trails is low in comparison to other budgetary needs within the City.

8.2.2 User Fees: The County of San Bernardino or a regional park district may establish a pleasure riding tax in accordance with the provisions of Government Code Sections 53940 et. seq.. Specifically this law permits the County to levy a tax of up to \$10.00 per horse or mule per year in order to finance the acquisition, construction, and maintenance of the County's recreational trails system. Since the majority of the City's Regional Trails are also part of the County designated trail system, the City could derive substantial benefit from such a user fee, particularly to defray maintenance costs currently born by the City. However, the County Regional Parks Department encourages local communities to finance their own community trail systems through special tax districts.

8.2.3 Grants: A variety of State and Federal funding programs exist which may be utilized to implement a trails program. Some of these are Federal revenue sharing under the State and Local Fiscal Assistance Act of 1972, and the 1988 California Wildlife, Coastal and Parkland Conservation Bond Act.

The California Park, Recreation, and Wildlife Enhancement Act of 1990 (AB 145), on the November 1990 ballot, will provide \$15 million statewide for "recreational trail development for trails recognized in local general plans, regional plans, master plans, or state plans." \$7.5 million each is proposed to be allocated for the 1992-93 and 1993-94 fiscal years.

Proposition 116, identified as the Rail Transportation Bond Act, is the Clean Air Transportation Improvement Act of 1990, is a statewide funding bill passed in June 1990 that provides monies for rail, ferryboat and public bicycle transportation. The Act will provide \$20 million on a competitive basis (\$4 million each over the next five years) to local agencies for capital outlay bicycle commuter projects. A wide range of bicycle trail improvements are eligible, including acquisition of right-of-way, design and construction costs.

The Federal Highways Act of 1973 and 1976 authorized a portion of Department of Transportation Federal Aid Urban Funds to be used for construction of bicycle and pedestrian facilities in conjunction with federal aid highway projects. Section 141 of the Act authorizes monies to be used by local communities for bikeways. Because the annual appropriation to the region, encompassing California, Arizona, Nevada and Hawaii, amounts to only \$400,000, the City should look to other funding sources first.

The State Office of Bicycle Facilities administers the Bicycle Lane Account, which receives a portion of the local's share of state gas tax revenues. Bicycle commuter facilities, including building a separate bike path, striping a bike lane or constructing parking facilities at major public sites, are given funding priority. As a condition for fund eligibility, the City should submit this Trails Implementation Plan for approval by Caltrans. The grants will fund 90 percent of project costs; however, the total allocation is only \$360,000 each year statewide. Local agencies must provide matching funds for the remaining 10 percent. Funding may be for both planning and construction of the specific project but cannot be used to maintain bikeways.

The State Department of Transportation (Caltrans) administers the State Highway Account. Section 156.10 of the Streets and Highways Code enables Caltrans to construct and maintain nonmotorized transportation facilities approximately paralleling any State highway where the separation of nonmotorized traffic from motor vehicle traffic will increase the traffic capacity or safety of the highway. An annual amount (minimum \$360,000) is set aside for such facilities (i.e., those designed primarily for use by pedestrians, bicyclist or equestrians) to be used in conjunction with State highways.

The Air Quality Management District has adopted strict standards for large employers in the region. These Regulation 15 standards require public and private employers with more than 100 employees to reduce the number of persons per vehicle who drive to work. At many work locations, showers and bike lockers are being provided to encourage bicycle commuting. Some companies have even purchased bicycles that employees may "borrow" for commuting. In addition, AQMD funding is available for improvements which encourage bicycle commuting.

8.2.4 General Obligation Bonds: Bonds, as a means of financing public facilities, are available for cities for any project considered to be of public benefit. This method would involve a vote of the people in order to sell bonds

for trail capital improvements purposes and would require a 662/3 percent vote in favor of such an issue. General obligation bonds have the advantage of costing a relatively small interest rate, they provide the use of trails while they are being paid for, and they also allow the accomplishment of trails under present cost and not under inflated future costs. Obtaining the required two-thirds majority vote may be difficult; however, a random survey of residents indicated that 67.9 percent felt it is important for the City to continue to build a trail system.

8.2.5 Special Assessment District: California Law authorizes a variety of assessment procedures which can be employed to pay for development of major capital expenditures. Through the assessment district, financing is arranged through bonds. Obligation for payment of financing is shared by those within the assessment district. For example, since the proposed community equestrian trails will be developed almost exclusively within the Equestrian/Rural Area, a potential method of financing the system is through the creation of a Special Trail Improvement District. Approval of the assessment district requires a substantial majority of property owners to agree to the formation of the district. This system works best for projects of limited scope and purpose.

San Bernardino County, in cooperation with cities, placed the formation of a Regional Park and Open Space District on the June 1991 ballot. Unfortunately, the measure failed by a substantial margin, in part due to the recessionary economy. The City of Rancho Cucamonga would have benefited from participating in the district through the construction of recreational projects. The Day Creek Regional Trail was identified as one potential project for Rancho Cucamonga. The measure, or one similar, may resurface on a future ballot again.

8.2.6 Reimbursement Agreements: Where appropriate, the City should consider authorizing reimbursement agreements between private developments and the City to cover improvement costs beyond those required as part of the project. Under these provisions, the City will enter into an agreement with the developer to complete a trail to reimburse them for the portion of improvement costs beyond their responsibility. The City would then reimburse the developer on charges collected from benefiting properties.

8.2.7 Maintenance District: Upon development, a maintenance district can be formed under the 1972 Landscape and Lighting Act. Such a district would have the ability to maintain trails and associated landscaping and lighting. Maintenance districts are a common practice in Rancho Cucamonga for assuring availability of ongoing revenues to support their service. Maintenance districts can include a large area of multiple parcel ownerships with an annual assessment being made to cover the necessary maintenance of trails within the district area.

8.2.8 Redevelopment Law: The City has established a Redevelopment Agency pursuant to State Community Redevelopment Law which allows communities to utilize tax increment financing to carry out redevelopment activities by applying tax increments obtained in the project area to finance planning, administrative, acquisition, for public purposes, construction of public facilities, such as roads, parks, and sewers, and administrative, legal, planning, and engineering costs related to the project. The City's Redevelopment Agency would issue bonds to finance costs and would apply the tax increments derived in the project area to pay the debt service on the bonds. Tax increments are those tax revenues received during the Base Year preceding adoption of the Redevelopment Plan.

8.3 ACQUISITION OF TRAILS

There are three major means of acquiring land for trails. These include: 1) the acquisition of the title in fee simple, 2) police power, and 3) acquisition of certain rights to the land (less than fee simple). The difficulty and complexity of establishing a long-term trails program requires that effort be made to utilize all three of the above means. Each method offers advantages and disadvantages, and it is important to creatively use all three methods to secure the most advantageous trail system.

8.3.1 Fee Simple: Outright ownership is the most effective way of maintaining trails over a long period of time. This can be accomplished through condemnation, purchase of tax delinquent lands, eminent domain, installment purchase, donation, open market purchase, or dedication.

Eminent domain has been used primarily in obtaining rights-of-way for streets and highways, municipal structures, parks, and urban renewal. This method of accomplishing public ownership of private lands might also be used to acquire open space lands. In order for this to occur, the City must show that the public benefits provided

by the land would be greater than the cost to the private owner.

Tax delinquent lands, when they are located so that they might implement trail systems, can be acquired by a community at less than market cost.

The burden of purchasing trail land can be lessened to some degree by purchasing via an installment process. In such a situation, Rancho Cucamonga would spread its bill for such acquisition over a number of years. The private owner might be allowed to control his property until the payments are concluded, or partly concluded. Such lands could continue to be productive and remain on the tax rolls until such time as the City would formalize the acquisition.

Dedication is a method of acquiring fee simple title to trail lands and is related to an express act pursuant to the City's police powers (i.e., a formal written offer and acceptance by the City). In exchange for granting approval of tract maps and development review applications, and therefore committing City funds for the provision and expansions of utilities and services, the City may require dedication of land for trail use. The developer profits through the added incentive the trails produce for home purchasers who desire recreational amenity.

8.3.2 Police Power: The authority of the City to promulgate and carry out zoning regulations is founded in the state delegated "police power." Article XI, Section 7 of the California Constitution states that "A county or city may make and enforce within its limits all local, police, sanitary, and other ordinances and regulations not in conflict with general laws." The most common application of police power is a community's zoning ordinance. Zoning is generally considered the primary tool for implementing the policies identified in the General Plan. The City adopted a Development Code (zoning ordinance) in 1983. The City's Development Code (Section 17.08.050.C.7) requires that a development project "provides local feeder trails and community trails as required by the General Plan."

8.3.3 Less than Fee Acquisition: In some instances, the City may desire to acquire trails through other means than fee simple, particularly where the cost of acquisition would be prohibitive or the use of police power is not feasible. Easements and joint use agreements are two alternative methods of acquiring trail rights.

Land ownership implies a complicated series of rights that the land owner possesses. The acquisition of an easement over private lands affords the City the potential of acquiring some of these rights. Usually easements allow a jurisdiction to use private lands for access for utility lines or roadways. Sometimes easements are granted for recreation purposes such as trail use.

The City is empowered by the Open Space Easement Act of 1974 to accept or approve a grant of open space easement from private landowners for trail corridors in return for tax incentives. This program would allow a landowner to receive a charitable contribution tax deduction for trail easement dedication as a condition of approval for a tract map or development project.

The Regional Trail System, and portions of the Community Trail system, should be implemented through joint use agreements with public and private agencies, such as, the San Bernardino County Flood Control District, and the Southern California Edison and Railroad companies, which control easements or rights-of-way across the City. The City has already instituted joint use agreements for recreational purposes along the Cucamonga Creek and Demens Creek Channels and is in process of negotiating for agreements on the remaining channel rights-of-way.

The Southern Pacific Railroad line that bisects the City from east-to-west is designated as a future Community Trail on the City's Master Plan of Trails. This rail line may be abandoned someday because of infrequent use. Under the National Trails Act Amendment of 1983, railroad companies can be compelled to "railbank" unused or abandoned segments against possible future need. In the meantime, they can be publicly managed as trails. The Rails-to-Trails Conservancy (RTC) was formed in 1985 to assist government agencies in obtaining and converting unused rail corridors to usable trails. The Southern Pacific/Sante Fe Railroad Company has agreed to notify the Rails-to-Trails Conservancy of rail abandonments six months before they are officially filed with the Interstate Commerce Commission. RTC has pledged, in turn, to notify cities so that each abandonment can be analyzed for its value as a trail.

8.3.4 Specific Plans & Community Plans: The California Government Code (Section 65450) allows local governments to prepare specific plans that will establish site development regulations, including areas to remain open space, such as trails and parks. The Industrial Area, Etiwanda, and Foothill Boulevard Specific Plans have been adopted by the City for selected parts of the community. These Plans include master plans and design standards for hiking, riding, and bicycling trails. In a similar fashion, the City has adopted community plans, with extensive trail networks, such as the Victoria, Terra Vista, and Caryn planned communities. All of these documents offer Rancho Cucamonga the opportunity to provide trails by regulating the design and layout of development schemes.

8.3.5 Local Feeder Trails: A special mention is needed with regard to Local Feeder trails. Some of the existing Local Feeder trails are designated by the General Plan *Master Plan of Trails*, and the *Hiking and Riding Master Plan* contained herein, as being planned for public use as a Community Trail. The Local Feeder trail easements are established on the final subdivision map pursuant to conditions of approval on the tentative map. They are private equestrian easements reserved for the use of all property owners within the given subdivision. To amend the usage of Local Feeder trails within an existing subdivision to use by the general public would require the City to acquire easement rights either by purchase from the individual lot owners or an action in eminent domain for public rights-of-way. With regard to eminent domain action, the requisite showing of public need and necessity to acquire the property by eminent domain may be difficult to substantiate.

8.3.6 Implied Dedication: The *General Plan Master Plan of Trails* reveals that certain Community Trails are made up of areas where the public has for a number of years traversed (apparently without argument) private property to get from one public trail to the next (either by using an existing private trail easement or by simply cutting across vacant property). Such historic use may imply dedication to the public of trail access rights under certain, very limited, circumstances. The theory of implied dedication -- adverse public use of private property for five years without substantial interference by the owner -- was established by the California Supreme Court in *Gion v. Santa Cruz* (1970). In that case, a road, parking area, and beach strip were privately owned; however, the public regularly used it for fishing, swimming and other recreational purposes over a period of many years. None of the private property owners had made any serious objections and the City of Santa Cruz had improved the area. The Supreme Court held that this constituted an implied dedication to the public and ruled that the only proof required is that persons use the property believing that there was a public right to do so, without objection or interference, for more than five years. Subsequently, the Legislature adopted California Civil Code Section 1009 requiring "express written irrevocable offer of dedication of such property to such use." Accordingly, any public use of private property to invoke the *Gion* rule would have to have commenced at, or prior to, approximately 1965 (e.g., at least five years of public use). If indeed there is a proper situation as described briefly above, the City of Rancho Cucamonga could establish its rights to the trail by a "quiet title" action to the trail easement.

8.4 PHASING OF TRAIL IMPROVEMENTS

The lists of trail projects below are not intended to be all inclusive. Rather, they are intended to list trail routes of community-wide or regional significance. The Trails Implementation Plan does not propose phases for construction of trail projects. This is due, in part, to Rancho Cucamonga's fast growth which has resulted, and will continue, in construction of trails as a requirement of development. Rather, the emphasis is on identifying priorities for possible projects to be used in preparing future budgets and capital improvement programs.

8.5 COMMUNITY HIKING & RIDING TRAIL IMPROVEMENT PROJECTS

The following priority list of capital improvement projects addresses improvement and rehabilitation of existing trails and some projects currently in planning stages. Projects should be reviewed annually through the City's established budget review process to adjust priority, as needed, based upon urgency, availability of funding, and revised cost estimates.

1. Alta Loma Storm Drain Trail - Remove fence and gate barricades where necessary to provide trail access

pursuant to joint use agreement with San Bernardino County Flood Control District. Install trail signing as needed, particularly at trail entrances. This section of trail follows the flood control channel and basins from the existing terminus of a Community Trail, within the tract located on the west side of Hermosa, below Almond, to the lower basins above Banyan. An important north-south trail could be established with minimal investment.

2. Almond Trail - Obtain right-of-way and construct trail link from Archibald west to Tract 11626. This trail section would provide access to the Demens Channel Regional Trail and Front Line Regional Trail, and would also provide access to Heritage Park, for residents in northeast Alta Loma. This section of trail passes across upper Demens Basin (San Bernardino County Flood Control District), private property at the end of Amethyst Street, and along a private local feeder trail easement at the north end of Tract 9521 or, alternatively, above Tract 9306.

3. Beechwood/Wilson Trail - Obtain right-of-way and construct missing link at 5706 Jasper Street. When Tract 9015 was originally laid out, a vital easement through the side yard on Lot 26 was not provided. This section of trail is the only gap in an otherwise continuous trail from the western City limits to Hellman, which will ultimately extend east all the way to the Deer Creek Channel Regional Trail. Trail users west of Jasper would get a "straight shot" trail to Heritage Park and the Demens Channel Regional Trail.

4. Sapphire Trail - Demonstration project to reconstruct existing parkway to a trail from Banyan to Hillside. This section on the west side of Sapphire is improved to varying degrees, in some cases with sidewalks. Numerous local feeder trails spill out onto the pavement. The speed and increasing volume of traffic on Sapphire make it a high priority for improvement. The trail would fit into the existing right-of-way dedication.

5. Hillside Trail - Reconstruct parkway to accommodate trail from Hellman to Amethyst. Hillside is developed with full street improvements and front-on homes. Completion of this section will provide access to Heritage Park and Demens Channel Regional Trail for property owners east of Amethyst.

6. Banyan Trail - Reconstruct parkway for trail from Sapphire to Archibald. Banyan is developed with a variety of conditions, including front-on homes and some stretches of dirt trail. The Banyan Trail is an important east-west trail through the heart of Alta Loma, which also forms the southerly boundary of the Equestrian-Rural Area (east of Sapphire). The length of this trail will dictate a multi-year phased project. Emphasis should be placed on providing a usable trail path where none presently exists.

7. Turquoise Trail - Acquire right-of-way and construct a trail from Banyan to Almond. This section of trail is part of the Primary Loop Trail system. This section begins at Banyan as part of the regional trail that follows the east side of Cucamonga Creek Channel to the base of the debris basin (approximately at the level of Jennet). From this point on, the trail runs through private trail easements within Tracts 9540 and 11893 (public access rights needed) and through a 20 foot wide Flood Control Channel easement until it merges with the power line easement north of Orchard Street.

8. Carnelian Trail - Acquire right-of-way and construct trail within parkway on east side of street. This section of Carnelian from Hillside to Almond is presently not developed to its full width and is characterized by larger land holdings with homes fronting onto the street.

9. Amethyst Trail - Acquire right-of-way and construct trail from Banyan to Almond. A difficult section of trail because it crosses the front yards of many homes, particularly between Wilson and Hillside. Sections of the trail exist in some form south of Wilson. Trail will follow east side of Amethyst from Banyan to Hillside, where it crosses over to the west side. Most of the right-of-way exists south of Hillside.

10. Archibald Trail - Construct trail from Wilson to Carrari. Right-of-way exists on the east side; however, right-of-way acquisition needed where trail crosses over to the west side between Hillside and Cinch Ring Lane.

11. Hermosa Trail - A lower priority trail because a trail exists for much of this stretch from Banyan to Almond or is being installed quickly as the area develops.

12. Haven Trail - Like Hermosa, this section of trail is being installed as development occurs. Renovation work

would include trail surfacing, fencing, and landscaping.

8.6 REGIONAL HIKING & RIDING TRAIL IMPROVEMENT PROJECTS

It is important to note that the Regional Trail system could be vastly improved on a short term basis with minor improvement, such as modifying existing gated entrances and landscaping to allow trail user access. Ultimate undercrossings to be installed below Banyan will be used by bicyclists and may be funded out of bicycle trail funds. Priority should be given to completing the undercrossings on one side of the channels before installing the extra undercrossings on the other side of channels north of Banyan (opposite from bicycle trail).

1. Joint-Use Agreements - The next step in implementing the Regional Hiking and Riding Trail system is to negotiate joint-use agreements with the San Bernardino County Flood Control District for Deer Creek, Hillside Channel, Day Creek, Almond Intercept Channel and the remaining portion of Cucamonga Creek (south of Base Line Road). The City has already begun discussions with the District regarding a "Master" Agreement.

2. Demens Creek - Minor improvements are necessary at street crossings to provide trail access, such as clearing of vegetation, texturized street pavement crossing, and trail signs to alert motorists at crossings. Relocate chain link fence around south and east sides of basin to provide a trail connection on top of basin levee over to Amethyst.

3. Cucamonga Creek - Minor improvements are necessary from Confluence Park north to Jennet, including fence relocation, and vegetation removal. North of Banyan, the chain link fence needs to be moved 20 feet to the west to provide Regional Trail paralleling a private local feeder trail. A 20 foot wide Community parkway trail on the west side of Turquoise, from Pearl Street north to Almond Intercept Channel, would provide an important link between the Cucamonga Creek Regional Trail and the Almond Intercept Channel Regional Trail.

4. Deer Creek - Modification to existing improvements at street crossings are needed to open up trail access. Trail signs, such as those used along Demens Creek, should be installed. Openings must be provided through chain link barricade that blocks north-south travel along the channel at the two existing pedestrian bridges (one north and one south of Base Line Road).

5. Day Creek - Upon completion of the channel, a traffic signal and grade crossing are needed at Arrow Route. A special at-grade crossing is needed at the A.T. & S.F. rail line. For additional comments see "Deer Creek" above.

6. Hillside Channel - Install trail signs and modify existing fences and gates to provide trail access.

7. Front Line - Trail access rights must be negotiated with utility companies and many private property owners. Due to this trails' location in the scenic foothills, the trail should be left as natural as possible. The trail follows fire road and utility service roads, except where it veers southwest along the Almond Intercept Channel.

8.7 BICYCLE TRAIL IMPROVEMENT PROJECTS

On -street bicycle lanes (Class II) are usually provided when streets are constructed, or reconstructed, or the pavement is overlaid. Thus, it is the street construction schedule that typically dictates a bicycle lane's implementation. Designated bike routes (Class III) are easily implemented since placement of signs is all that is required. Implementation of these facilities can be done at such time as the need becomes apparent.

Separated bike paths (Class I) are sometimes constructed as development occurs, such as within the planned communities. Most bike paths are located along flood control channels and utilize the existing or future asphalt service roads. Therefore, implementation is simply a matter of negotiating agreements with other public agencies and private utilities. However, for the flood control channels to properly function as a regional trail facility for bicyclists, it will be necessary to construct underpasses at street crossings. For example, street underpasses were built along the Cucamonga Creek Channel Regional Trail at the 19th Street and Base Line Road crossings. Because

of the high cost of such underpasses, consideration should be given to coordinating these with planned bridge construction or reconstruction projects.

Again, the following list of recommended bike trail projects is not all-inclusive, and projects may be added as funding becomes available or priorities may shift:

1. Base Line Road Demonstration Project - Stripe and sign the bike lane for the full length of Base Line.
2. Sign the Class II and Class III bicycle trail system, including pavement markings, wherever the ultimate pavement width exists.
3. Church Street and Terra Vista Parkway - relocate lane line 12' from median, and install "BIKE ROUTE" signs, from Haven Avenue to Terra Vista Parkway (East).
4. Regional Trail system - construct bicycle trail access by modifying existing access gates at service road entrances.
5. Publish a Bicycle Trails Map.
6. Study feasibility of bicycle activated signalization.
7. Complete ultimate design improvements for Class I system along flood channels, including, street underpasses, lighting, and signs.

APPENDIX

A



APPENDIX

9.1 Preliminary Construction Estimates

9.2 Financing Plan

9.3 Trail Standard Drawings

9.4 Ordinance - Trail Maintenance Standards

9.5 Ordinance - Bicycle Storage Facilities

9.6 Trails Coordinator Job Description

9.1 PRELIMINARY CONSTRUCTION ESTIMATES

Construction estimates have been provided for each classification of trail within the City's trail system. Costs are broken down into two (2) basic types; bikeways and hiking and riding trails. Bikeway trail costs are given for the three (3) classifications of Class I, Class II and Class III. Hiking and Riding Trail costs are provided for Regional Multi-Purpose and Community trails. These estimates were developed through extensive map and field evaluations based on trail development standards for each type of trail.

The following development standards were used in the cost projects for each trail:

I. BIKEWAYS

A. Class I

1. Land Acquisition - development will occur in flood control easements on existing service roads. This eliminates the need for land acquisition and results in no cost for acquisition.
2. Pavement - the A.C. trail surface will be in place with the use of service roads. No cost for pavement is required.
3. Pavement Markings - bike trail markings (symbols) are provided on the trail at 1/8th mile intervals (660 feet). Lane striping is not provided.
4. Signage - trail signs will be installed at trail entrances and identification and directional signs provided along the trail at 1/8th mile intervals (660 feet).
5. Lighting - trail lighting will be provided along the trail at 200 foot intervals on 15 foot high double arm light poles.
6. Undercrossings - road undercrossings are provided at all intersections with roads to maintain a separate trail alignment. Construction requires a grade separation at a depth of 10 feet with a 10 foot width.

This grade separation requires construction of a 10-foot high retaining wall for ± 800 feet, relocation of public utilities, realignment of storm drain pipe and catch basins, and replacement of paved service roads.

7. **Signal Crossings** - signal light crossings are provided for all street crossings at the Southern Pacific Railroad and crossings along the Day Creek Trail at Arrow Route and A.T. & S.F. Railroad.

B. Class II

1. **Land Acquisition** - the bike trail is located on existing city streets and requires no acquisition.
2. **Pavement** - no additional pavement is needed since the trail is on existing street pavement.
3. **Pavement Markings** - the bike trail symbols shall be provided at 1/8th mile intervals (660 feet).
4. **Pavement Lane Lines** - the bike trail shall be separated from traffic with a lane line. This painted line shall be continuous along the length of the trail.
5. **Signage** - trail signs will be provided along the trail at 1/8th mile intervals (660 feet). These signs will consist of trail identification and directional signs.
6. **Lighting** - not applicable. Street lighting will provide appropriate illumination.
7. **Undercrossings at Roads** - not applicable.
8. **Signal Crossings** - not applicable.

C. Class III

1. **Land Acquisition** - trail will be on existing city streets and requires no acquisition.
2. **Pavement** - no additional pavement is needed since the trail is on existing city streets.
3. **Pavement Markings** - bike trail symbols shall be located on the street surface at 1/8th mile intervals (660 feet).
4. **Pavement Lane Lines** - trails are located on city streets with no trail delineation on pavement surfaces. No pavement lane lines are provided.

5. Signage - bike trail identification and directional signs shall be provided at 1/8th mile intervals (660 feet).
6. Lighting - street lighting will provide proper trail illumination. No additional lighting will be provided.
7. Undercrossings at Roads - not applicable.
8. Signal Crossings - not applicable.

II. HIKING AND RIDING TRAILS

A. Regional Multi-Purpose

1. Grading - Regional trails are located primarily along flood control channels and require minimal grading of a 12' wide area and excavation of 4" for placement of decomposed granite. The Frontline Regional Trail only requires fine grading of a 12' wide area with no excavation.
2. Decomposed Granite - trail along flood control channels shall be constructed with a 4" thick decomposed granite surface. No redwood or concrete header will be used at the trail edge. The Frontline Regional Trail will utilize natural soils.
3. Signage - trail identification and directional signs shall be provided at 1/8th mile intervals (660 feet) and at trail entrances.
4. Fencing at Hazard Areas - chainlink fencing will be provided in trail areas where grade changes along the trail are considered hazardous.
5. Lighting - trail lighting shall be provided on separated trails north of Banyan Street at 200 foot intervals on 15 foot high light poles. No additional lighting is provided south of Banyan Street where lighting is shared with adjacent Class I bike trails.
6. Undercrossings - separate road undercrossings from Class I bike trails are provided to maintain a separate trail alignment north of Banyan Street. Construction requires a grade separation with a 10 foot depth and width. Separate undercrossings are not provided south of Banyan Street where a single common undercrossing is provided for both Class I bikeway and Regional hiking and riding trails.

This grade separation requires construction of a 10 foot high retaining wall for +800 feet, relocation of public utilities, realignment of storm drain pipe and catch basins, and replacement of paved service roads.

B. Community Trails

1. **Land Acquisition** - acquisition of additional public right-of-way and land needed to link existing sections of trails is included. Land acquisition is primarily needed in older sections of the city where final links are missing and must be acquired to complete the trail system.
2. **Demolition and Reconstruction** - community trails are located in public right-of-ways along streets and in many cases require demolition and reconstruction of existing features. Each community trail has been inventoried to identify demolition and reconstruction items needed for each trail section. Demolition items include landscape and irrigation, concrete sidewalks, garden planter walls, and tree removal. Reconstruction includes regrading and new retaining walls where required to maintain trail width.
3. **Grading** - Community trails are located in level areas along city streets in public right-of-way and require minimal grading and excavation of 4" for placement of decomposed granite.
4. **Decomposed Granite** - Community trails shall be constructed with a 4" thick decomposed granite surface.
5. **Signage** - trail identification and directional signs shall be provided at 1/8th mile intervals (660 feet).
6. **Fencing and Concrete Curb** - each trail shall have fencing and concrete curbs on both sides per city standards, except in cases where a trail is located along a wall in a minimal width right-of-way.
7. **Bridges** - hiking and riding trail bridges shall be provided across flood control channels at designated locations.

A comprehensive spreadsheet and individual cost estimates have been provided for each section of trail to allow for specific funding allocations as funding becomes available. Each project is identified by location and length with an itemized list of construction and cost assumptions. Projects which require demolition and reconstruction (Community Trails) have an inventory listing of assumptions based on site observations. This comprehensive estimate will serve as a planning tool for implementation of the trail system for many years. As funding is obtained from sources with specific application, this estimate will allow planners an opportunity to identify appropriate trail sections that qualify within funding limitations and provide efficient development strategies to be implemented. In addition to construction costs, "other costs" necessary to develop a trail system have been budgeted for and include: administration 22% (Planning 3%, Engineering 4%, Finance 15%), design 12%, and construction inspection 8%. The costs for each project is summarized by construction costs and other costs that allow budgeting for all aspects of project development.

CITY OF RANCHO CUCAMONGA
Summary of Trails Construction Costs
November 4, 1991

	<u>OPTION A</u> <u>Full System</u>	<u>OPTION B</u> <u>No Undercrossings</u>	<u>OPTION C</u> <u>No Undercrossings/Fencing</u>
I. BIKEWAYS			
A. Class I	\$37,842,517	\$ 5,466,517	\$ 5,466,517
B. Class II	198,042	198,042	198,042
C. Class III	<u>117,354</u>	<u>117,354</u>	<u>117,354</u>
Total =	\$38,157,913	\$ 5,781,913	\$ 5,781,913
II. HIKING AND RIDING TRAILS			
A. Regional Multi-Purpose	\$13,738,983	\$ 3,514,983	\$ 3,514,983
B. Community	<u>21,012,265</u>	<u>21,012,265</u>	<u>5,912,553</u>
Total =	\$34,751,248	\$24,527,248	\$ 9,427,536
GRAND TOTAL =	\$72,909,161	\$30,309,161	\$15,209,449

Note: With the adoption of the Trails Implementation Plan on October 16, 1991, the City Council selected Option A, while recognizing that implementation of the full system is a long term goal that will take decades to fulfill.

COST ESTIMATE

BIKEWAYS CLASS I

Cucamonga Creek

N. City Limits - 19th Street (11,000 l.f.)

	<u>Item</u>	<u>Quantity</u>	<u>Unit Price</u>	<u>Total</u>
1.	Land Acquisition	N/A	-----	-----
2.	Pavement	N/A	-----	-----
3.	Pavement Markings	18 EA	12.00	216
4.	Signage	18 EA	130.00	2,340
5.	Lighting	56 EA	3,000.00	168,000
6.	Undercrossings at Roads	N/A	-----	-----
7.	Signal Crossings	N/A	-----	-----
				<hr/>
			TOTAL:	\$170,556

COST ESTIMATE

BIKEWAYS CLASS I

Cucamonga Creek

19th Street - Base Line (4,500 l.f.)

	<u>Item</u>	<u>Quantity</u>	<u>Unit Price</u>	<u>Total</u>
1.	Land Acquisition	N/A	-----	-----
2.	Pavement	N/A	-----	-----
3.	Pavement Markings	8 EA	12.00	96
4.	Signage	8 EA	130.00	1,040
5.	Lighting	24 EA	3,000.00	72,000
6.	Undercrossings at Roads	N/A	-----	-----
7.	Signal Crossings	N/A	-----	-----
TOTAL:				\$73,136

COST ESTIMATE

BIKEWAYS CLASS I

Cucamonga Creek

Base Line - Foothill Blvd. (5,500 l.f.)

	<u>Item</u>	<u>Quantity</u>	<u>Unit Price</u>	<u>Total</u>
1.	Land Acquisition	N/A	-----	-----
2.	Pavement	N/A	-----	-----
3.	Pavement Markings	9 EA	12.00	108
4.	Signage	9 EA	130.00	1,170
5.	Lighting	29 EA	3,000.00	87,000
6.	Undercrossings at Roads	2 EA	1,200,000.00	2,400,000
7.	Signal Crossings	N/A	-----	-----
				<hr/>
			TOTAL:	\$2,488,278

COST ESTIMATE

BIKEWAYS CLASS I

Cucamonga Creek

Foothill Blvd - Arrow Route (2,500 l.f.)

	<u>Item</u>	<u>Quantity</u>	<u>Unit Price</u>	<u>Total</u>
1.	Land Acquisition	N/A	-----	-----
2.	Pavement	N/A	-----	-----
3.	Pavement Markings	5 EA	12.00	60
4.	Signage	5 EA	130.00	650
5.	Lighting	14 EA	3,000.00	42,000
6.	Undercrossings at Roads	N/A	-----	-----
7.	Signal Crossings	N/A	-----	-----
TOTAL:				\$42,710

COST ESTIMATE

BIKEWAYS CLASS I

Cucamonga Creek

Arrow Route - 4th Street (800 l.f.)

	<u>Item</u>	<u>Quantity</u>	<u>Unit Price</u>	<u>Total</u>
1.	Land Acquisition	N/A	-----	-----
2.	Pavement	N/A	-----	-----
3.	Pavement Markings	3 EA	12.00	36
4.	Signage	3 EA	130.00	390
5.	Lighting	5 EA	3,000.00	15,000
6.	Undercrossings at Roads	N/A	-----	-----
7.	Signal Crossings	N/A	-----	-----
				<hr/>
			TOTAL:	\$15,426

COST ESTIMATE

BIKEWAYS CLASS I

Demens Channel

N. City Limits - Cucamonga Creek (9,000 l.f.)

	<u>Item</u>	<u>Quantity</u>	<u>Unit Price</u>	<u>Total</u>
1.	Land Acquisition	N/A	-----	-----
2.	Pavement	N/A	-----	-----
3.	Pavement Markings	15 EA	12.00	180
4.	Signage	15 EA	130.00	1,950
5.	Lighting	46 EA	3,000.00	138,000
6.	Undercrossings at Roads	2 EA	1,200,000.00	2,400,000
7.	Signal Crossings	N/A	-----	-----
TOTAL:				\$2,540,130

COST ESTIMATE

BIKEWAYS CLASS I

Deer Creek

N. City Limit - Main Creek Intersection (7,000 l.f.)

	<u>Item</u>	<u>Quantity</u>	<u>Unit Price</u>	<u>Total</u>
1.	Land Acquisition	N/A	-----	-----
2.	Pavement	N/A	-----	-----
3.	Pavement Markings	12 EA	12.00	144
4.	Signage	12 EA	130.00	1,560
5.	Lighting	36 EA	3,000.00	108,000
6.	Undercrossings at Roads	N/A	-----	-----
7.	Signal Crossings	N/A	-----	-----
TOTAL:				<hr/> \$109,704

COST ESTIMATE

BIKEWAYS CLASS I

Deer Creek

Main Creek Intersection - Highland Avenue (7,500 l.f.)

<u>Item</u>	<u>Quantity</u>	<u>Unit Price</u>	<u>Total</u>
1. Land Acquisition	N/A	-----	-----
2. Pavement	N/A	-----	-----
3. Pavement Markings	12 EA	12.00	144
4. Signage	12 EA	130.00	1,560
5. Lighting	39 EA	3,000.00	117,000
6. Undercrossings at Roads	2 EA	1,200,000.00	2,400,000
7. Signal Crossings	N/A	-----	-----
TOTAL:			<u>\$2,518,704</u>

COST ESTIMATE

BIKEWAYS CLASS I

Deer Creek

Highland Avenue - Base Line (5,500 l.f.)

	<u>Item</u>	<u>Quantity</u>	<u>Unit Price</u>	<u>Total</u>
1.	Land Acquisition	N/A	-----	-----
2.	Pavement	N/A	-----	-----
3.	Pavement Markings	9 EA	12.00	108
4.	Signage	9 EA	130.00	1,170
5.	Lighting	29 EA	3,000.00	87,000
6.	Undercrossings at Roads	3 EA	1,200,000.00	3,600,000
7.	Signal Crossings	N/A	-----	-----
TOTAL:				\$3,688,278

COST ESTIMATE

BIKEWAYS CLASS I

Deer Creek

Base Line - Foothill Blvd. (5,500 l.f.)

	<u>Item</u>	<u>Quantity</u>	<u>Unit Price</u>	<u>Total</u>
1.	Land Acquisition	N/A	-----	-----
2.	Pavement	N/A	-----	-----
3.	Pavement Markings	9 EA	12.00	108
4.	Signage	9 EA	130.00	1,170
5.	Lighting	29 EA	3,000.00	87,000
6.	Undercrossings at Roads	1 EA	1,200,000.00	1,200,000
7.	Signal Crossings	N/A	-----	-----
				<hr/>
			TOTAL:	\$1,288,278

COST ESTIMATE

BIKEWAYS CLASS I

Deer Creek

Foothill Blvd. - Arrow Route (2,500 l.f.)

	<u>Item</u>	<u>Quantity</u>	<u>Unit Price</u>	<u>Total</u>
1.	Land Acquisition	N/A	-----	-----
2.	Pavement	N/A	-----	-----
3.	Pavement Markings	5 EA	12.00	60
4.	Signage	5 EA	130.00	650
5.	Lighting	14 EA	3,000.00	42,000
6.	Undercrossings at Roads	N/A	-----	-----
7.	Signal Crossings	N/A	-----	-----
				<hr/>
			TOTAL:	\$42,710

COST ESTIMATE

BIKEWAYS CLASS I

Deer Creek

Arrow Route - 4th Street (7,500 l.f.)

	<u>Item</u>	<u>Quantity</u>	<u>Unit Price</u>	<u>Total</u>
1.	Land Acquisition	N/A	-----	-----
2.	Pavement	N/A	-----	-----
3.	Pavement Markings	12 EA	12.00	144
4.	Signage	12 EA	130.00	1,560
5.	Lighting	39 EA	3,000.00	117,000
6.	Undercrossings at Roads	N/A	-----	-----
7.	Signal Crossings	N/A	-----	-----
				<hr/>
			TOTAL:	\$118,704

COST ESTIMATE

BIKEWAYS CLASS I

Day Creek

N. City Limit (Wilson Avenue) - Highland Avenue (5,000 l.f.)

	<u>Item</u>	<u>Quantity</u>	<u>Unit Price</u>	<u>Total</u>
1.	Land Acquisition	N/A	-----	-----
2.	Pavement	N/A	-----	-----
3.	Pavement Markings	9 EA	12.00	108
4.	Signage	9 EA	130.00	1,170
5.	Lighting	26 EA	3,000.00	78,000
6.	Undercrossings at Roads	2 EA	1,200,000.00	2,400,000
7.	Signal Crossings	N/A	-----	-----
TOTAL:				\$2,479,278

COST ESTIMATE

BIKEWAYS CLASS I

Day Creek

Highland Avenue - Base Line (5,000 l.f.)

	<u>Item</u>	<u>Quantity</u>	<u>Unit Price</u>	<u>Total</u>
1.	Land Acquisition	N/A	-----	-----
2.	Pavement	40,000 SF	1.50	60,000
3.	Pavement Markings	9 EA	12.00	108
4.	Signage	9 EA	130.00	1,170
5.	Lighting	26 EA	3,000.00	78,000
6.	Undercrossings at Roads	3 EA	1,200,000.00	3,600,000
7.	Signal Crossings	N/A	-----	-----
TOTAL:				\$3,739,278

COST ESTIMATE

BIKEWAYS CLASS I

Day Creek

Base Line - Foothill Blvd. (5,000 l.f.)

	<u>Item</u>	<u>Quantity</u>	<u>Unit Price</u>	<u>Total</u>
1.	Land Acquisition	N/A	-----	-----
2.	Pavement	N/A	-----	-----
3.	Pavement Markings	9 EA	12.00	108
4.	Signage	9 EA	130.00	1,170
5.	Lighting	26 EA	3,000.00	78,000
6.	Undercrossings at Roads	2 EA	1,200,000.00	2,400,000
7.	Signal Crossings	N/A	-----	-----
				<hr/>
			TOTAL:	\$2,479,278

COST ESTIMATE

BIKEWAYS CLASS I

Day Creek

Foothill Blvd. - Arrow Route (3,000 l.f.)

	<u>Item</u>	<u>Quantity</u>	<u>Unit Price</u>	<u>Total</u>
1.	Land Acquisition	N/A	-----	-----
2.	Pavement	N/A	-----	-----
3.	Pavement Markings	6 EA	12.00	72
4.	Signage	6 EA	130.00	780
5.	Lighting	16 EA	3,000.00	48,000
6.	Undercrossings at Roads	N/A	-----	-----
7.	Signal Crossings	1 EA	30,000.00	30,000
				<hr/>
			TOTAL:	\$78,852

COST ESTIMATE

BIKEWAYS CLASS I

Day Creek

Arrow Route - 4th Street (7,500 l.f.)

	<u>Item</u>	<u>Quantity</u>	<u>Unit Price</u>	<u>Total</u>
1.	Land Acquisition	N/A	-----	-----
2.	Pavement	N/A	-----	-----
3.	Pavement Markings	12 EA	12.00	144
4.	Signage	12 EA	130.00	1,560
5.	Lighting	39 EA	3,000.00	117,000
6.	Undercrossings at Roads	2 EA	1,200,000.00	2,400,000
7.	Signal Crossings	1 EA	50,000.00	50,000

			TOTAL:	\$2,568,704

COST ESTIMATE

BIKEWAYS CLASS I

Etiwanda Avenue

24th Street - Highland Avenue (5,000 l.f.)

	<u>Item</u>	<u>Quantity</u>	<u>Unit Price</u>	<u>Total</u>
1.	Land Acquisition	N/A	-----	-----
2.	Pavement	40,000 S.F.	1.50	60,000
3.	Pavement Markings	9 EA	12.00	108
4.	Signage	9 EA	130.00	1,170
5.	Lighting	26 EA	3,000.00	78,000
6.	Undercrossings at Roads	N/A	-----	-----
7.	Signal Crossings	N/A	-----	-----
				<hr/>
			TOTAL:	\$139,278

COST ESTIMATE

BIKEWAYS CLASS I

Etiwanda Avenue

Highland Avenue - Base Line (5,500 l.f.)

	<u>Item</u>	<u>Quantity</u>	<u>Unit Price</u>	<u>Total</u>
1.	Land Acquisition	N/A	-----	-----
2.	Pavement	44,000 S.F.	1.50	66,000
3.	Pavement Markings	9 EA	12.00	108
4.	Signage	9 EA	130.00	1,170
5.	Lighting	29 EA	3,000.00	87,000
6.	Undercrossings at Roads	N/A	-----	-----
7.	Signal Crossings	N/A	-----	-----
				<hr/>
			TOTAL:	\$154,278

COST ESTIMATE

BIKEWAYS CLASS I

24th Street

City Limit (W) - Etiwanda Avenue (3,000 l.f.)

	<u>Item</u>	<u>Quantity</u>	<u>Unit Price</u>	<u>Total</u>
1.	Land Acquisition	N/A	-----	-----
2.	Pavement	24,000 S.F.	1.50	36,000
3.	Pavement Markings	6 EA	12.00	72
4.	Signage	6 EA	130.00	780
5.	Lighting	16 EA	3,000.00	48,000
6.	Undercrossings at Roads	N/A	-----	-----
7.	Signal Crossings	N/A	-----	-----
				<hr/>
			TOTAL:	\$84,852

COST ESTIMATE

BIKEWAYS CLASS I

24th Street

Etiwanda Avenue - East Avenue (2,500 l.f.)

	<u>Item</u>	<u>Quantity</u>	<u>Unit Price</u>	<u>Total</u>
1.	Land Acquisition	N/A	-----	-----
2.	Pavement	20,000 S.F.	1.50	30,000
3.	Pavement Markings	5 EA	12.00	60
4.	Signage	5 EA	130.00	650
5.	Lighting	14 EA	3,000.00	42,000
6.	Undercrossings at Roads	N/A	-----	-----
7.	Signal Crossings	N/A	-----	-----
				<hr/>
			TOTAL:	\$72,710

COST ESTIMATE

BIKEWAYS CLASS I

24th Street

East Avenue - Wardman Bullock Road (3,000 l.f.)

	<u>Item</u>	<u>Quantity</u>	<u>Unit Price</u>	<u>Total</u>
1.	Land Acquisition	N/A	-----	-----
2.	Pavement	24,000 S.F.	1.50	36,000
3.	Pavement Markings	6 EA	12.00	72
4.	Signage	6 EA	130.00	780
5.	Lighting	16 EA	3,000.00	48,000
6.	Undercrossings at Roads	N/A	-----	-----
7.	Signal Crossings	N/A	-----	-----
				<hr/>
			TOTAL:	\$84,852

COST ESTIMATE

BIKEWAYS CLASS I

24th Street

Wardman Bullock Road - Cherry Avenue (5,500 l.f.)

	<u>Item</u>	<u>Quantity</u>	<u>Unit Price</u>	<u>Total</u>
1.	Land Acquisition	N/A	-----	-----
2.	Pavement	44,000 S.F.	1.50	66,000
3.	Pavement Markings	9 EA	12.00	108
4.	Signage	9 EA	130.00	1,170
5.	Lighting	29 EA	3,000.00	87,000
6.	Undercrossings at Roads	N/A	-----	-----
7.	Signal Crossings	N/A	-----	-----
TOTAL:				<hr/> \$154,278

COST ESTIMATE

BIKEWAYS CLASS I

Southern Pacific Railroad
W. City Limit - Grove Avenue (500 l.f.)

	<u>Item</u>	<u>Quantity</u>	<u>Unit Price</u>	<u>Total</u>
1.	Land Acquisition	N/A	-----	-----
2.	Pavement	4,000 S.F.	1.50	6,000
3.	Pavement Markings	2 EA	12.00	24
4.	Signage	2 EA	130.00	260
5.	Lighting	4 EA	3,000.00	12,000
6.	Undercrossings at Roads	N/A	-----	-----
7.	Signalized Crossings	7 EA	12,000.00	84,000
				<hr/>
			TOTAL:	\$102,284

COST ESTIMATE

BIKEWAYS CLASS I

Southern Pacific Railroad
Grove Avenue - Base Line (11,000 l.f.)

<u>Item</u>	<u>Quantity</u>	<u>Unit Price</u>	<u>Total</u>
1. Land Acquisition	N/A	-----	-----
2. Pavement	88,000 S.F.	1.50	132,000
3. Pavement Markings	18 EA	12.00	216
4. Signage	18 EA	130.00	2,340
5. Lighting	56 EA	3,000.00	168,000
6. Undercrossings at Roads	N/A	-----	-----
7. Signalized Crossings	4 EA	12,000.00	48,000
			<hr/>
		TOTAL:	\$350,556

COST ESTIMATE

BIKEWAYS CLASS I

Southern Pacific Railroad

Base Line - Archibald Avenue (3,000 l.f.)

<u>Item</u>	<u>Quantity</u>	<u>Unit Price</u>	<u>Total</u>
1. Land Acquisition	N/A	-----	-----
2. Pavement	24,000 S.F.	1.50	36,000
3. Pavement Markings	6 EA	12.00	72
4. Signage	6 EA	130.00	780
5. Lighting	16 EA	3,000.00	48,000
6. Undercrossings at Roads	N/A	-----	-----
7. Signalized Crossings	2 EA	12,000.00	24,000
			<hr/>
		TOTAL:	\$108,852

COST ESTIMATE

BIKEWAYS CLASS I

Southern Pacific Railroad

Archibald Avenue - Haven Avenue (5,000 l.f.)

	<u>Item</u>	<u>Quantity</u>	<u>Unit Price</u>	<u>Total</u>
1.	Land Acquisition	N/A	-----	-----
2.	Pavement	40,000 S.F.	1.50	60,000
3.	Pavement Markings	9 EA	12.00	108
4.	Signage	9 EA	130.00	1,170
5.	Lighting	26 EA	3,000.00	78,000
6.	Undercrossings at Roads	N/A	-----	-----
7.	Signalized Crossings	5 EA	12,000.00	60,000
				<hr/>
			TOTAL:	\$199,278

COST ESTIMATE

BIKEWAYS CLASS I

Southern Pacific Railroad

Haven Avenue - Milliken Avenue (5,000 l.f.)

	<u>Item</u>	<u>Quantity</u>	<u>Unit Price</u>	<u>Total</u>
1.	Land Acquisition	N/A	-----	-----
2.	Pavement	40,000 S.F.	1.50	60,000
3.	Pavement Markings	9 EA	12.00	108
4.	Signage	9 EA	130.00	1,170
5.	Lighting	26 EA	3,000.00	78,000
6.	Undercrossings at Roads	N/A	-----	-----
7.	Signalized Crossings	1 EA	12,000.00	12,000
				<hr/>
			TOTAL:	\$151,278

COST ESTIMATE

BIKEWAYS CLASS I

Southern Pacific Railroad

Milliken Avenue - Rochester Avenue (4,000 l.f.)

	<u>Item</u>	<u>Quantity</u>	<u>Unit Price</u>	<u>Total</u>
1.	Land Acquisition	N/A	-----	-----
2.	Pavement	32,000 S.F.	1.50	48,000
3.	Pavement Markings	7 EA	12.00	84
4.	Signage	7 EA	130.00	910
5.	Lighting	21 EA	3,000.00	63,000
6.	Undercrossings at Roads	N/A	-----	-----
7.	Signalized Crossings	2 EA	12,000.00	24,000
				<hr/>
			TOTAL:	\$135,994

COST ESTIMATE

BIKEWAYS CLASS I

Southern Pacific Railroad

Rochester Avenue - Etiwanda Avenue (6,500 l.f.)

	<u>Item</u>	<u>Quantity</u>	<u>Unit Price</u>	<u>Total</u>
1.	Land Acquisition	N/A	-----	-----
2.	Pavement	52,000 S.F.	1.50	78,000
3.	Pavement Markings	11 EA	12.00	132
4.	Signage	11 EA	30.00	330
5.	Lighting	34 EA	3,000.00	102,000
6.	Undercrossings at Roads	N/A	-----	-----
7.	Signalized Crossings	3 EA	12,000.00	36,000
				<hr/>
			TOTAL:	\$216,462

COST ESTIMATE

BIKEWAYS CLASS I

Southern Pacific Railroad

Etiwanda Avenue - E. City Limit (3,500 l.f.)

<u>Item</u>	<u>Quantity</u>	<u>Unit Price</u>	<u>Total</u>
1. Land Acquisition	N/A	-----	-----
2. Pavement	28,000 S.F.	1.50	42,000
3. Pavement Markings	6 EA	12.00	72
4. Signage	6 EA	130.00	780
5. Lighting	19 EA	3,000.00	57,000
6. Undercrossings at Roads	N/A	-----	-----
7. Signalized Crossings	1 EA	12,000.00	12,000
			<hr/>
		TOTAL:	\$111,852

COST ESTIMATE

BIKEWAYS CLASS I

Terra Vista Greenway

Milliken Avenue - Rochester Avenue (4,000 l.f.)

	<u>Item</u>	<u>Quantity</u>	<u>Unit Price</u>	<u>Total</u>
1.	Land Acquisition	N/A	-----	-----
2.	Pavement	32,000 S.F.	1.50	80,000
3.	Pavement Markings	6 EA	12.00	72
4.	Signage	6 EA	130.00	780
5.	Lighting	20 EA	3,000.00	60,000
6.	Undercrossings at Roads	N/A	-----	-----
7.	Signalized Crossings	N/A	-----	-----
				<hr/>
			TOTAL:	220,140

COST ESTIMATE

BIKEWAYS CLASS II

Etiwanda Avenue

Base Line - Foothill Blvd. (5,000 l.f.)

	<u>Item</u>	<u>Quantity</u>	<u>Unit Price</u>	<u>Total</u>
1.	Pavement Markings	16 EA	12.00	192
2.	Pavement Lane Lines	10,000 L.F.	.23	2,300
3.	Signage	16 EA	130.00	2,080
				<hr/>
		TOTAL:		\$4,572

COST ESTIMATE

BIKEWAYS CLASS II

Etiwanda Avenue

Foothill Blvd. - Arrow Route (2,500 l.f.)

<u>Item</u>	<u>Quantity</u>	<u>Unit Price</u>	<u>Total</u>
2. Pavement Markings	9 EA	12.00	108
2. Pavement Lane Lines	5,000 L.F.	.23	1,150
3. Signage	9 EA	130.00	1,170
TOTAL:			<hr/> \$2,428

COST ESTIMATE

BIKEWAYS CLASS II

Etiwanda Avenue

Arrow Route - 4th Street (7,500 l.f.)

	<u>Item</u>	<u>Quantity</u>	<u>Unit Price</u>	<u>Total</u>
1.	Pavement Markings	24 EA.	12.00	288
2.	Pavement Lane Lines	15,000 L.F.	.23	3,450
3.	Signage	24 EA	130.00	3,120
				<hr/>
TOTAL:				\$6,858

COST ESTIMATE

BIKEWAYS CLASS II

East Avenue

24th Street - Highland Avenue (5,500 l.f.)

	<u>Item</u>	<u>Quantity</u>	<u>Unit Price</u>	<u>Total</u>
1.	Pavement Markings	18 EA	12.00	216
2.	Pavement Lane Lines	11,000 L.F.	.23	2,530
3.	Signage	18 EA	130.00	2,340
				<hr/>
TOTAL:				\$5,086

COST ESTIMATE

BIKEWAYS CLASS II

East Avenue

Highland Ave. - Base Line (5,000 l.f.)

	<u>Item</u>	<u>Quantity</u>	<u>Unit Price</u>	<u>Total</u>
1.	Pavement Markings	16 EA	12.00	192
2.	Pavement Lane Lines	10,000 L.F.	.23	2,300
3.	Signage	16 EA	130.00	2,080
				<hr/>
		TOTAL:		\$4,572

COST ESTIMATE

BIKEWAYS CLASS II

24th Street

Cherry Avenue - E. City Limit (3,000 l.f.)

	<u>Item</u>	<u>Quantity</u>	<u>Unit Price</u>	<u>Total</u>
1.	Pavement Markings	10 EA	12.00	120
2.	Pavement Lane Lines	6,000 L.F.	.23	1,380
3.	Signage	10 EA	130.00	1,300
				<hr/>
			TOTAL:	\$2,800

COST ESTIMATE

BIKEWAYS CLASS II

19th Street

W. City Limit - Carnelian Street (3,000 l.f.)

	<u>Item</u>	<u>Quantity</u>	<u>Unit Price</u>	<u>Total</u>
1.	Pavement Markings	10 EA	12.00	120
2.	Pavement Lane Lines	6,000 L.F.	.23	1,380
3.	Signage	10 EA	130.00	1,300
TOTAL:				<hr/> \$2,800

COST ESTIMATE

BIKEWAYS CLASS II

19th Street

Carnelian Street - Archibald Avenue (6,500 l.f.)

	<u>Item</u>	<u>Quantity</u>	<u>Unit Price</u>	<u>Total</u>
1.	Pavement Markings	21 EA	12.00	252
2.	Pavement Lane Lines	13,000 L.F.	.23	2,990
3.	Signage	21 EA	130.00	2,730
				<hr/>
			TOTAL:	\$5,972

COST ESTIMATE

BIKEWAYS CLASS II

19th Street

Archibald Avenue - Haven Avenue (5,000 l.f.)

	<u>Item</u>	<u>Quantity</u>	<u>Unit Price</u>	<u>Total</u>
1.	Pavement Markings	16 EA	12.00	192
2.	Pavement Lane Lines	10,000 L.F.	.23	2,300
3.	Signage	16 EA	130.00	2,080
				<hr/>
			TOTAL:	\$4,572

COST ESTIMATE

BIKEWAYS CLASS II

19th Street

Haven Avenue - Highland Avenue (3,500 l.f.)

	<u>Item</u>	<u>Quantity</u>	<u>Unit Price</u>	<u>Total</u>
1.	Pavement Markings	12 EA	12.00	144
2.	Pavement Lane Lines	7,000 L.F.	.23	1,610
3.	Signage	12 EA	130.00	1,560
				<hr/>
TOTAL:				\$3,314

COST ESTIMATE

BIKEWAYS CLASS II

Victoria Park Lane

Milliken Avenue - Rochester Avenue (5,000 l.f.)

	<u>Item</u>	<u>Quantity</u>	<u>Unit Price</u>	<u>Total</u>
1.	Pavement Markings	16 EA	12.00	192
2.	Pavement Lane Lines	10,000 L.F.	.23	2,300
3.	Signage	16 EA	130.00	2,080
				<hr/>
		TOTAL:		\$4,572

COST ESTIMATE

BIKEWAYS CLASS II

Victoria Park Lane

Rochester Avenue - E. of Future Day Creek Blvd. (2,000 l.f.)

	<u>Item</u>	<u>Quantity</u>	<u>Unit Price</u>	<u>Total</u>
1.	Pavement Markings	7 EA	12.00	84
2.	Pavement Lane Lines	4,000 L.F.	.23	920
3.	Signage	7 EA	130.00	910
				<hr/>
TOTAL:				\$1,914

COST ESTIMATE

BIKEWAYS CLASS II

Victoria Park Lane

E. of Future Day Creek Blvd. - Base Line (4,000 l.f.)

	<u>Item</u>	<u>Quantity</u>	<u>Unit Price</u>	<u>Total</u>
1.	Pavement Markings	13 EA	12.00	156
2.	Pavement Lane Lines	8,000 L.F.	.23	1,840
3.	Signage	13 EA	130.00	1,690
				<hr/>
		TOTAL:		\$3,686

COST ESTIMATE

BIKEWAYS CLASS II

Victoria Park Lane

Base Line - Miller Avenue (3,000 l.f.)

	<u>Item</u>	<u>Quantity</u>	<u>Unit Price</u>	<u>Total</u>
1.	Pavement Markings	10 EA	12.00	120
2.	Pavement Lane Lines	6,000 L.F.	.23	1,380
3.	Signage	10 EA	130.00	1,300
				<hr/>
			TOTAL:	\$2,800

COST ESTIMATE

BIKEWAYS CLASS II

Base Line

W. City Limit - Carnelian Street (2,500 l.f.)

	<u>Item</u>	<u>Quantity</u>	<u>Unit Price</u>	<u>Total</u>
1.	Pavement Markings	9 EA	12.00	108
2.	Pavement Lane Lines	5,000 L.F.	.23	1,150
3.	Signage	9 EA	130.00	1,170
				<hr/>
			TOTAL:	\$2,428

COST ESTIMATE

BIKEWAYS CLASS II

Base Line

Carnelian Street - Archibald Avenue (6,500 l.f.)

	<u>Item</u>	<u>Quantity</u>	<u>Unit Price</u>	<u>Total</u>
1.	Pavement Markings	21 EA	12.00	252
2.	Pavement Lane Lines	13,000 L.F.	.23	2,990
3.	Signage	21 EA	130.00	2,730
				<hr/>
		TOTAL:		\$5,972

COST ESTIMATE

BIKEWAYS CLASS II

Base Line

Archibald Avenue - Haven Avenue (5,000 l.f.)

	<u>Item</u>	<u>Quantity</u>	<u>Unit Price</u>	<u>Total</u>
1.	Pavement Markings	16 EA	12.00	192
2.	Pavement Lane Lines	10,000 L.F.	.23	2,300
3.	Signage	16 EA	130.00	2,080
				<hr/>
			TOTAL:	\$4,572

COST ESTIMATE

BIKEWAYS CLASS II

Base Line

Haven Avenue - Milliken Avenue (5,000 l.f.)

	<u>Item</u>	<u>Quantity</u>	<u>Unit Price</u>	<u>Total</u>
1.	Pavement Markings	16 EA	12.00	192
2.	Pavement Lane Lines	10,000 L.F.	.23	2,300
3.	Signage	16 EA	130.00	2,080
				<hr/>
			TOTAL:	\$4,572

COST ESTIMATE

BIKEWAYS CLASS II

Base Line

Milliken Avenue - Rochester Avenue (4,000 l.f.)

	<u>Item</u>	<u>Quantity</u>	<u>Unit Price</u>	<u>Total</u>
1.	Pavement Markings	13 EA	12.00	156
2.	Pavement Lane Lines	8,000 L.F.	.23	1,840
3.	Signage	13 EA	130.00	1,690
				<hr/>
			TOTAL:	\$3,686

COST ESTIMATE

BIKEWAYS CLASS II

Base Line

Rochester Avenue - Etiwanda Avenue (6,500 l.f.)

	<u>Item</u>	<u>Quantity</u>	<u>Unit Price</u>	<u>Total</u>
1.	Pavement Markings	21 EA	12.00	252
2.	Pavement Lane Lines	13,000 L.F.	.23	2,990
3.	Signage	21 EA	130.00	2,730
				<hr/>
TOTAL:				\$5,972

COST ESTIMATE

BIKEWAYS CLASS II

Base Line

Etiwanda Avenue - E. City Limit (2,500 l.f.)

	<u>Item</u>	<u>Quantity</u>	<u>Unit Price</u>	<u>Total</u>
1.	Pavement Markings	9 EA	12.00	108
2.	Pavement Lane Lines	5,000 L.F.	.23	1,150
3.	Signage	9 EA	130.00	1,170
				<hr/>
			TOTAL:	\$2,428

COST ESTIMATE

BIKEWAYS CLASS II

Miller Avenue

Rochester Avenue - Etiwanda Avenue (7,500 l.f.)

	<u>Item</u>	<u>Quantity</u>	<u>Unit Price</u>	<u>Total</u>
1.	Pavement Markings	24 EA	12.00	288
2.	Pavement Lane Lines	15,000 L.F.	.23	3,450
3.	Signage	24 EA	130.00	3,120
				<hr/>
TOTAL:				\$6,858

COST ESTIMATE

BIKEWAYS CLASS II

Arrow Route

Baker Avenue - Archibald Avenue (7,500 l.f.)

	<u>Item</u>	<u>Quantity</u>	<u>Unit Price</u>	<u>Total</u>
1.	Pavement Markings	24 EA	12.00	288
2.	Pavement Lane Lines	15,000 L.F.	.23	3,450
3.	Signage	24 EA	130.00	3,120
				<hr/>
TOTAL:				\$6,858

COST ESTIMATE

BIKEWAYS CLASS II

Arrow Route

Archibald Avenue - Haven Avenue (5,000 l.f.)

	<u>Item</u>	<u>Quantity</u>	<u>Unit Price</u>	<u>Total</u>
1.	Pavement Markings	16 EA	12.00	192
2.	Pavement Lane Lines	10,000 L.F.	.23	2,300
3.	Signage	16 EA	130.00	2,080
				<hr/>
TOTAL:				\$4,572

COST ESTIMATE

BIKEWAYS CLASS II

Arrow Route

Haven Avenue - Milliken Avenue (5,500 l.f.)

	<u>Item</u>	<u>Quantity</u>	<u>Unit Price</u>	<u>Total</u>
1.	Pavement Markings	18 EA	12.00	216
2.	Pavement Lane Lines	11,000 L.F.	.23	2,530
3.	Signage	18 EA	130.00	2,340
				<hr/>
TOTAL:				\$5,086

COST ESTIMATE

BIKEWAYS CLASS II

Arrow Route

Milliken Avenue - Rochester Avenue (3,000 l.f.)

	<u>Item</u>	<u>Quantity</u>	<u>Unit Price</u>	<u>Total</u>
1.	Pavement Markings	10 EA	12.00	120
2.	Pavement Lane Lines	6,000 L.F.	.23	1,380
3.	Signage	10 EA	130.00	1,300
				<hr/>
			TOTAL:	\$2,800

COST ESTIMATE

BIKEWAYS CLASS II

Arrow Route

Rochester Avenue - Etiwanda Avenue (3,500 l.f.)

	<u>Item</u>	<u>Quantity</u>	<u>Unit Price</u>	<u>Total</u>
1.	Pavement Markings	12 EA	12.00	144
2.	Pavement Lane Lines	7,000 L.F.	.23	1,610
3.	Signage	12 EA	130.00	1,560
				<hr/>
		TOTAL:		\$3,314

COST ESTIMATE

BIKEWAYS CLASS II

Arrow Route

Etiwanda Avenue - E. City Limit (3,000 l.f.)

	<u>Item</u>	<u>Quantity</u>	<u>Unit Price</u>	<u>Total</u>
1.	Pavement Markings	10 EA	12.00	120
2.	Pavement Lane Lines	6,000 L.F.	.23	1,380
3.	Signage	10 EA	130.00	1,300
				<hr/>
TOTAL:				\$2,800

COST ESTIMATE

BIKEWAYS CLASS II

4th Street

Cucamonga Creek - Archibald Avenue (2,000 l.f.)

	<u>Item</u>	<u>Quantity</u>	<u>Unit Price</u>	<u>Total</u>
1.	Pavement Markings	7 EA	12.00	84
2.	Pavement Lane Lines	4,000 L.F.	.23	920
3.	Signage	7 EA	130.00	910
TOTAL:				<hr/> \$1,914

COST ESTIMATE

BIKEWAYS CLASS II

4th Street

Archibald Avenue - Haven Avenue (5,000 l.f.)

	<u>Item</u>	<u>Quantity</u>	<u>Unit Price</u>	<u>Total</u>
1.	Pavement Markings	16 EA	12.00	192
2.	Pavement Lane Lines	10,000 L.F.	.23	2,300
3.	Signage	16 EA	130.00	2,080
				<hr/>
TOTAL:				\$4,572

COST ESTIMATE

BIKEWAYS CLASS II

4th Street

Haven Avenue - Milliken Avenue (5,000 l.f.)

	<u>Item</u>	<u>Quantity</u>	<u>Unit Price</u>	<u>Total</u>
1.	Pavement Markings	16 EA	12.00	192
2.	Pavement Lane Lines	10,000 L.F.	.23	2,300
3.	Signage	16 EA	130.00	2,080
				<hr/>
TOTAL:				\$4,572

COST ESTIMATE

BIKEWAYS CLASS II

4th Street

Milliken Avenue - Etiwanda Avenue (10,000 l.f.)

	<u>Item</u>	<u>Quantity</u>	<u>Unit Price</u>	<u>Total</u>
1.	Pavement Markings	31 EA	12.00	372
2.	Pavement Lane Lines	20,000 L.F.	.23	4,600
3.	Signage	31 EA	130.00	4,030
				<hr/>
			TOTAL:	\$9,002

COST ESTIMATE

BIKEWAYS CLASS II

Pioneer Way

Rochester Avenue - Pioneer Way (1,500)

	<u>Item</u>	<u>Quantity</u>	<u>Unit Price</u>	<u>Total</u>
1.	Pavement Markings	6 EA	12.00	72
2.	Pavement Lane Lines	3,000 L.F.	.23	690
3.	Signage	6 EA	130.00	780
				<hr/>
		TOTAL:		\$1,542

COST ESTIMATE

BIKEWAYS CLASS III

Archibald Avenue

N. City Limit - Wilson Avenue (5,000 l.f.)

	<u>Item</u>	<u>Quantity</u>	<u>Unit Price</u>	<u>Total</u>
1.	Pavement Markings	16 EA	12.00	192
2.	Signage	16 EA	130.00	2,080
				<hr/>
TOTAL:				\$2,272

COST ESTIMATE

BIKEWAYS CLASS III

Archibald Avenue

Wilson Avenue - 19th Street (6,500 l.f.)

	<u>Item</u>	<u>Quantity</u>	<u>Unit Price</u>	<u>Total</u>
1.	Pavement Markings	21 EA	12.00	252
2.	Signage	21 EA	130.00	2,730
				<hr/>
TOTAL:				\$2,982

COST ESTIMATE

BIKEWAYS CLASS III

Archibald Avenue

19th Street - Base Line (4,000 l.f.)

	<u>Item</u>	<u>Quantity</u>	<u>Unit Price</u>	<u>Total</u>
1.	Pavement Markings	13 EA	12.00	156
2.	Signage	13 EA	130.00	1,690
				<hr/>
			TOTAL:	\$1,846

COST ESTIMATE

BIKEWAYS CLASS III

Archibald Avenue

Base Line - Foothill Blvd. (5,000 l.f.)

	<u>Item</u>	<u>Quantity</u>	<u>Unit Price</u>	<u>Total</u>
1.	Pavement Markings	16 EA	12.00	192
2.	Signage	16 EA	130.00	2,080
				<hr/>
			TOTAL:	\$2,272

COST ESTIMATE

BIKEWAYS CLASS III

Archibald Avenue

Foothill Blvd. - Arrow Route (2,500 l.f.)

	<u>Item</u>	<u>Quantity</u>	<u>Unit Price</u>	<u>Total</u>
1.	Pavement Markings	9 EA	12.00	108
2.	Signage	9 EA	130.00	1,170
				<hr/>
			TOTAL:	\$1,278

COST ESTIMATE

BIKEWAYS CLASS III

Archibald Avenue

Arrow Route - 4th Street (7,500 l.f.)

	<u>Item</u>	<u>Quantity</u>	<u>Unit Price</u>	<u>Total</u>
1.	Pavement Markings	24 EA	12.00	288
2.	Signage	24 EA	130.00	3,120
				<hr/>
			TOTAL:	\$3,408

COST ESTIMATE

BIKEWAYS CLASS III

Milliken Avenue

Wilson Avenue - Highland Avenue (5,000 l.f.)

	<u>Item</u>	<u>Quantity</u>	<u>Unit Price</u>	<u>Total</u>
1.	Pavement Markings	16 EA	12.00	192
2.	Signage	16 EA	130.00	2,080
				<hr/>
			TOTAL:	\$2,272

COST ESTIMATE

BIKEWAYS CLASS III

Milliken Avenue

Highland Avenue - Base Line (5,000 l.f.)

	<u>Item</u>	<u>Quantity</u>	<u>Unit Price</u>	<u>Total</u>
1.	Pavement Markings	16 EA	12.00	192
2.	Signage	16 EA	130.00	2,080
				<hr/>
			TOTAL:	\$2,272

COST ESTIMATE

BIKEWAYS CLASS III

Milliken Avenue

Base Line - Foothill Blvd. (5,000 l.f.)

	<u>Item</u>	<u>Quantity</u>	<u>Unit Price</u>	<u>Total</u>
1.	Pavement Markings	16 EA	12.00	192
2.	Signage	16 EA	130.00	2,080
				<hr/>
			TOTAL:	\$2,272

COST ESTIMATE

**BIKEWAYS
CLASS III**

Milliken Avenue

Foothill Blvd. - Arrow Route (2,500 l.f.)

	<u>Item</u>	<u>Quantity</u>	<u>Unit Price</u>	<u>Total</u>
1.	Pavement Markings	9 EA	12.00	108
2.	Signage	9 EA	130.00	1,170
				<hr/>
			TOTAL:	\$1,278

COST ESTIMATE

BIKEWAYS CLASS III

Milliken Avenue

Arrow Route - 4th Street (7,500 l.f.)

	<u>Item</u>	<u>Quantity</u>	<u>Unit Price</u>	<u>Total</u>
1.	Pavement Markings	24 EA	12.00	288
2.	Signage	24 EA	130.00	3,120
				<hr/>
			TOTAL:	\$3,408

COST ESTIMATE

BIKEWAYS CLASS III

Wilson Avenue

Haven Avenue - Milliken Avenue (5,000 l.f.)

	<u>Item</u>	<u>Quantity</u>	<u>Unit Price</u>	<u>Total</u>
1.	Pavement Markings	16 EA	12.00	192
2.	Signage	16 EA	130.00	2,080
				<hr/>
			TOTAL:	\$2,272

COST ESTIMATE

BIKEWAYS CLASS III

Wilson Avenue

Milliken Avenue - Rochester Avenue (4,000 l.f.)

	<u>Item</u>	<u>Quantity</u>	<u>Unit Price</u>	<u>Total</u>
1.	Pavement Markings	13 EA	12.00	156
2.	Signage	13 EA	130.00	1,690
				<hr/>
			TOTAL:	\$1,846

COST ESTIMATE

**BIKEWAYS
CLASS III**

Wilson Avenue

Rochester Avenue - Day Creek (3,500 l.f.)

	<u>Item</u>	<u>Quantity</u>	<u>Unit Price</u>	<u>Total</u>
1.	Pavement Markings	12 EA	12.00	144
2.	Signage	12 EA	130.00	1,560
				<hr/>
			TOTAL:	\$1,704

COST ESTIMATE

BIKEWAYS CLASS III

Highland Avenue

19th Street - Milliken Avenue (1,500 l.f.)

	<u>Item</u>	<u>Quantity</u>	<u>Unit Price</u>	<u>Total</u>
1.	Pavement Markings	6 EA	12.00	72
2.	Signage	6 EA	130.00	780
				<hr/>
			TOTAL:	\$852

COST ESTIMATE

BIKEWAYS CLASS III

Highland Avenue

Milliken Avenue - Rochester Avenue (4,000 l.f.)

	<u>Item</u>	<u>Quantity</u>	<u>Unit Price</u>	<u>Total</u>
1.	Pavement Markings	13 EA	12.00	156
2.	Signage	13 EA	130.00	1,690
TOTAL:				<hr/> \$1,846

COST ESTIMATE

BIKEWAYS CLASS III

Highland Avenue

Rochester Avenue - East of Future Day Creek Blvd. (2,000 l.f.)

	<u>Item</u>	<u>Quantity</u>	<u>Unit Price</u>	<u>Total</u>
1.	Pavement Markings	7 EA	12.00	84
2.	Signage	7 EA	130.00	910
				<hr/>
			TOTAL:	\$994

COST ESTIMATE

BIKEWAYS CLASS III

Highland Avenue

East of Future Day Creek Blvd. - Etiwanda (4,500 l.f.)

	<u>Item</u>	<u>Quantity</u>	<u>Unit Price</u>	<u>Total</u>
1.	Pavement Markings	15 EA	12.00	180
2.	Signage	15 EA	130.00	1,950
				<hr/>
TOTAL:				\$2,130

COST ESTIMATE

BIKEWAYS CLASS III

Highland Avenue

Etiwanda Avenue - E. City Limit (7,000 l.f.)

	<u>Item</u>	<u>Quantity</u>	<u>Unit Price</u>	<u>Total</u>
1.	Pavement Markings	22 EA	12.00	264
2.	Signage	22 EA	130.00	2,860
				<hr/>
			TOTAL:	\$3,124

COST ESTIMATE

BIKEWAYS CLASS III

Victoria Street

W. of Etiwanda Avenue - E. City Limit (5,500 l.f.)

	<u>Item</u>	<u>Quantity</u>	<u>Unit Price</u>	<u>Total</u>
1.	Pavement Markings	18 EA	12.00	216
2.	Signage	18 EA	130.00	2,340
				<hr/>
TOTAL:				\$2,556

COST ESTIMATE

BIKEWAYS CLASS III

Church Street

Hellman Avenue - Haven Avenue (8,000 l.f.)

	<u>Item</u>	<u>Quantity</u>	<u>Unit Price</u>	<u>Total</u>
1.	Pavement Markings	25 EA	12.00	300
2.	Signage	25 EA	130.00	3,250
				<hr/>
			TOTAL:	\$3,550

COST ESTIMATE

BIKEWAYS CLASS III

Church Street

Haven Avenue - Rochester Avenue (9,000 l.f.)

	<u>Item</u>	<u>Quantity</u>	<u>Unit Price</u>	<u>Total</u>
1.	Pavement Markings	28 EA	12.00	336
2.	Signage	28 EA	130.00	3,640
				<hr/>
			TOTAL:	\$3,976

COST ESTIMATE

BIKEWAYS CLASS III

Terra Vista Parkway West
Church Street - Milliken Avenue (4,500 l.f.)

	<u>Item</u>	<u>Quantity</u>	<u>Unit Price</u>	<u>Total</u>
1.	Pavement Markings	15 EA	12.00	180
2.	Signage	15 EA	130.00	1,950
				<hr/>
			TOTAL:	\$2,130

COST ESTIMATE

BIKEWAYS CLASS III

Terra Vista Parkway East
Milliken Avenue - Church Street (3,500 l.f.)

	<u>Item</u>	<u>Quantity</u>	<u>Unit Price</u>	<u>Total</u>
1.	Pavement Markings	12 EA	12.00	144
2.	Signage	12 EA	130.00	1,560
				<hr/>
TOTAL:				\$1,704

COST ESTIMATE

BIKEWAYS CLASS III

Beryl Street

Hillside Street - Banyan Street (4,000 l.f.)

	<u>Item</u>	<u>Quantity</u>	<u>Unit Price</u>	<u>Total</u>
1.	Pavement Markings	13 EA	12.00	156
2.	Signage	13 EA	130.00	1,690
				<hr/>
		TOTAL:		\$1,846

COST ESTIMATE

BIKEWAYS CLASS III

Beryl Street

Banyan Street - 19th Street (4,000 l.f.)

	<u>Item</u>	<u>Quantity</u>	<u>Unit Price</u>	<u>Total</u>
1.	Pavement Markings	13 EA	12.00	156
2.	Signage	13 EA	130.00	1,690
				<hr/>
			TOTAL:	\$1,846

COST ESTIMATE

BIKEWAYS **CLASS III**

Beryl Street

19th Street - Base Line (4,000 l.f.)

	<u>Item</u>	<u>Quantity</u>	<u>Unit Price</u>	<u>Total</u>
1.	Pavement Markings	13 EA	12.00	156
2.	Signage	13 EA	130.00	1,690
				<hr/>
			TOTAL:	\$1,846

COST ESTIMATE

BIKEWAYS CLASS III

Haven Avenue

Hillside Street - Wilson Avenue (1,000 l.f.)

	<u>Item</u>	<u>Quantity</u>	<u>Unit Price</u>	<u>Total</u>
1.	Pavement Markings	4 EA	12.00	48
2.	Signage	4 EA	130.00	520
				<hr/>
		TOTAL:		\$568

COST ESTIMATE

**BIKEWAYS
CLASS III**

Haven Avenue

Banyan Street - 19th Street (1,500 l.f.)

	<u>Item</u>	<u>Quantity</u>	<u>Unit Price</u>	<u>Total</u>
1.	Pavement Markings	6 EA	12.00	72
2.	Signage	6 EA	130.00	780
				<hr/>
TOTAL:				\$852

COST ESTIMATE

BIKEWAYS CLASS III

Hillside Street

W. City Limit - Carnelian Street (6,000 l.f.)

	<u>Item</u>	<u>Quantity</u>	<u>Unit Price</u>	<u>Total</u>
1.	Pavement Markings	19 EA	12.00	228
2.	Signage	19 EA	130.00	2,470
				<hr/>
TOTAL:				\$2,698

COST ESTIMATE

BIKEWAYS CLASS III

Hillside Street

Carnelian Street - Archibald Avenue (6,500 l.f.)

	<u>Item</u>	<u>Quantity</u>	<u>Unit Price</u>	<u>Total</u>
1.	Pavement Markings	21 EA	12.00	252
2.	Signage	21 EA	130.00	2,730
				<hr/>
			TOTAL:	\$2,982

COST ESTIMATE

**BIKEWAYS
CLASS III**

Hillside Street

Archibald Avenue - Haven Avenue (5,000 l.f.)

	<u>Item</u>	<u>Quantity</u>	<u>Unit Price</u>	<u>Total</u>
1.	Pavement Markings	16 EA	12.00	192
2.	Signage	16 EA	130.00	2,080
				<hr/>
			TOTAL:	\$2,272

COST ESTIMATE

BIKEWAYS CLASS III

Banyan Street

W. City Limit - Carnelian Street (5,000 l.f.)

	<u>Item</u>	<u>Quantity</u>	<u>Unit Price</u>	<u>Total</u>
1.	Pavement Markings	16 EA	12.00	192
2.	Signage	16 EA	130.00	2,080
				<hr/>
			TOTAL:	\$2,272

COST ESTIMATE

BIKEWAYS CLASS III

Banyan Street

Carnelian Street - Archibald Avenue (6,500 l.f.)

	<u>Item</u>	<u>Quantity</u>	<u>Unit Price</u>	<u>Total</u>
1.	Pavement Markings	21 EA	12.00	252
2.	Signage	21 EA	130.00	2,730
				<hr/>
			TOTAL:	\$2,982

COST ESTIMATE

BIKEWAYS CLASS III

Banyan Street

Haven Avenue - Milliken Avenue (5,000 l.f.)

	<u>Item</u>	<u>Quantity</u>	<u>Unit Price</u>	<u>Total</u>
1.	Pavement Markings	16 EA	12.00	192
2.	Signage	16 EA	130.00	2,080
				<hr/>
			TOTAL:	\$2,272

COST ESTIMATE

BIKEWAYS CLASS III

Banyan Street

Milliken Avenue - Day Creek Blvd. (5,000 l.f.)

	<u>Item</u>	<u>Quantity</u>	<u>Unit Price</u>	<u>Total</u>
1.	Pavement Markings	16 EA	12.00	192
2.	Signage	16 EA	130.00	2,080
				<hr/>
			TOTAL:	\$2,272

COST ESTIMATE

BIKEWAYS CLASS III

Banyan Street (south of)

Archibald Avenue - Haven Avenue (5,000 l.f.)

	<u>Item</u>	<u>Quantity</u>	<u>Unit Price</u>	<u>Total</u>
1.	Pavement Markings	16 EA	12.00	192
2.	Signage	16 EA	130.00	2,080
				<hr/>
			TOTAL:	\$2,272

COST ESTIMATE

BIKEWAYS CLASS III

Arrow Route

W. City Limit - Baker Avenue (3,000 l.f.)

	<u>Item</u>	<u>Quantity</u>	<u>Unit Price</u>	<u>Total</u>
1.	Pavement Markings	10 EA	12.00	120
2.	Signage	10 EA	130.00	1,300
				<hr/>
		TOTAL:		\$1,420

COST ESTIMATE

HIKING AND RIDING TRAILS REGIONAL MULTI-PURPOSE

Cucamonga Creek

N. City Limits - 19th Street (11,000 l.f.)

	<u>Item</u>	<u>Quantity</u>	<u>Unit Price</u>	<u>Total</u>
1.	Grading	132,000 S.F.	.40	52,800
2.	Decomposed Granite	132,000 S.F.	.50	66,000
3.	Signage	18 EA	130.00	2,340
4.	Fencing at Hazard Areas	N/A		-----
5.	Lighting	56 EA	3,000.00	168,000
6.	Undercrossings at Roads	N/A		-----
			TOTAL:	\$289,140

COST ESTIMATE

HIKING AND RIDING TRAILS REGIONAL MULTI-PURPOSE

Cucamonga Creek

19th Street - Base Line (4,000 l.f.)

	<u>Item</u>	<u>Quantity</u>	<u>Unit Price</u>	<u>Total</u>
1.	Grading	48,000 S.F.	.40	19,200
2.	Decomposed Granite	48,000 S.F.	.50	24,000
3.	Signage	7 EA	130.00	910
4.	Fencing at Hazard Areas	N/A	-----	-----
5.	Lighting	N/A	-----	-----
6.	Undercrossings at Roads	N/A	-----	-----
				<hr/>
			TOTAL:	\$44,110

COST ESTIMATE

HIKING AND RIDING TRAILS REGIONAL MULTI-PURPOSE

Cucamonga Creek

Base Line - Foothill Blvd. (5,500 l.f.)

	<u>Item</u>	<u>Quantity</u>	<u>Unit Price</u>	<u>Total</u>
1.	Grading	66,000 S.F.	.40	26,400
2.	Decomposed Granite	66,000 S.F.	.50	33,000
3.	Signage	9 EA	130.00	1,170
4.	Fencing at Hazard Areas	N/A	-----	-----
5.	Lighting	N/A	-----	-----
6.	Undercrossings at Roads	N/A	-----	-----
TOTAL:				\$60,570

COST ESTIMATE

HIKING AND RIDING TRAILS REGIONAL MULTI-PURPOSE

Cucamonga Creek

Foothill Blvd. - Arrow Route (2,500 l.f.)

	<u>Item</u>	<u>Quantity</u>	<u>Unit Price</u>	<u>Total</u>
1.	Grading	30,000 S.F.	.40	12,000
2.	Decomposed Granite	30,000 S.F.	.50	15,000
3.	Signage	5 EA	130.00	650
4.	Fencing at Hazard Areas	N/A	-----	-----
5.	Lighting	N/A	-----	-----
6.	Undercrossings at Roads	N/A	-----	-----
				<hr/>
			TOTAL:	\$27,650

COST ESTIMATE

HIKING AND RIDING TRAILS REGIONAL MULTI-PURPOSE

Cucamonga Creek

Arrow Route - 4th Street (9,000 l.f.)

	<u>Item</u>	<u>Quantity</u>	<u>Unit Price</u>	<u>Total</u>
1.	Grading	108,000 S.F.	.40	43,200
2.	Decomposed Granite	108,000 S.F.	.50	54,000
3.	Signage	15 EA	130.00	1,950
4.	Fencing at Hazard Areas	N/A	-----	-----
5.	Lighting	N/A	-----	-----
6.	Undercrossings at Roads	N/A	-----	-----
				<hr/>
			TOTAL:	\$99,150

COST ESTIMATE

HIKING AND RIDING TRAILS REGIONAL MULTI-PURPOSE

Almond Intercept Channel

Cucamonga Creek - Almond Avenue (3,000 l.f.)

	<u>Item</u>	<u>Quantity</u>	<u>Unit Price</u>	<u>Total</u>
1.	Grading	36,000 S.F.	.40	14,400
2.	Decomposed Granite	36,000 S.F.	.50	18,000
3.	Signage	6 EA	130.00	780
4.	Fencing at Hazard Areas	N/A	-----	-----
5.	Lighting	16 EA	3,000.00	45,000
6.	Undercrossings at Roads	N/A	-----	-----
				<hr/>
			TOTAL:	\$78,180

COST ESTIMATE

HIKING AND RIDING TRAILS REGIONAL MULTI-PURPOSE

Demens Channel

Rural Area N. of City Limit - N. City Limit (1,000 l.f.)

	<u>Item</u>	<u>Quantity</u>	<u>Unit Price</u>	<u>Total</u>
1.	Grading	12,000 S.F.	.40	4,800
2.	Decomposed Granite	12,000 S.F.	.50	6,000
3.	Signage	3 EA	130.00	390
4.	Fencing at Hazard Areas	N/A	-----	-----
5.	Lighting	6 EA	3,000.00	18,000
6.	Undercrossings at Roads	N/A	-----	-----
TOTAL:				\$29,190

COST ESTIMATE

HIKING AND RIDING TRAILS REGIONAL MULTI-PURPOSE

Demens Channel

N. City Limits - Cucamonga Creek (14,000 l.f.)

	<u>Item</u>	<u>Quantity</u>	<u>Unit Price</u>	<u>Total</u>
1.	Grading	168,000 S.F.	.40	67,200
2.	Decomposed Granite	168,000 S.F.	.50	84,000
3.	Signage	22 EA	130.00	2,860
4.	Fencing at Hazard Areas	400 L.F.	25.00	10,000
5.	Lighting	71 EA	3,000.00	213,000
6.	Undercrossings at Roads	2 EA	1,200,000.00	2,400,000
				<hr/>
			TOTAL:	\$2,777,060

COST ESTIMATE

**HIKING AND RIDING TRAILS
REGIONAL MULTI-PURPOSE**

Woods Trail

Dam Basin - Deer Creek Channel

DEVELOPED AND DEDICATED

COST ESTIMATE

HIKING AND RIDING TRAILS REGIONAL MULTI-PURPOSE

Hillside Channel

Dam Basin - Deer Creek Channel (8,000 l.f.)

	<u>Item</u>	<u>Quantity</u>	<u>Unit Price</u>	<u>Total</u>
1.	Grading	96,000 S.F.	.40	38,400
2.	Decomposed Granite	96,000 S.F.	.50	48,000
3.	Signage	13 EA	130.00	1,690
4.	Fencing at Hazard Areas	N/A	-----	-----
5.	Lighting	41 EA	3,000.00	123,000
6.	Undercrossings at Roads	N/A	-----	-----
				<hr/>
			TOTAL:	\$211,090

COST ESTIMATE

HIKING AND RIDING TRAILS REGIONAL MULTI-PURPOSE

Deer Creek

Deer Creek - Highland Avenue (7,000 l.f.)

	<u>Item</u>	<u>Quantity</u>	<u>Unit Price</u>	<u>Total</u>
1.	Grading	84,000 S.F.	.40	33,600
2.	Decomposed Granite	84,000 S.F.	.50	42,000
3.	Signage	12 EA	130.00	1,560
4.	Fencing at Hazard Areas	N/A	-----	-----
5.	Lighting	36 EA	3,000.00	108,000
6.	Undercrossings at Roads	2 EA	1,200,000.00	2,400,000
				<hr/>
			TOTAL:	\$2,585,160

COST ESTIMATE

HIKING AND RIDING TRAILS REGIONAL MULTI-PURPOSE

Deer Creek

Highland Avenue - Base Line (5,000 l.f.)

	<u>Item</u>	<u>Quantity</u>	<u>Unit Price</u>	<u>Total</u>
1.	Grading	60,000 S.F.	.40	24,000
2.	Decomposed Granite	60,000 S.F.	.50	30,000
3.	Signage	9 EA	130.00	1,170
4.	Fencing at Hazard Areas	N/A	-----	-----
5.	Lighting	N/A	-----	-----
6.	Undercrossings at Roads	N/A	-----	-----
				<hr/>
			TOTAL:	\$55,170

COST ESTIMATE

HIKING AND RIDING TRAILS REGIONAL MULTI-PURPOSE

Deer Creek

Base Line - Foothill Blvd. (6,000 l.f.)

	<u>Item</u>	<u>Quantity</u>	<u>Unit Price</u>	<u>Total</u>
1.	Grading	72,000 S.F.	.40	28,800
2.	Decomposed Granite	72,000 S.F.	.50	36,000
3.	Signage	10 EA	130.00	1,300
4.	Fencing at Hazard Areas	N/A	-----	-----
5.	Lighting	N/A	-----	-----
6.	Undercrossings at Roads	N/A	-----	-----
				<hr/>
			TOTAL:	\$66,100

COST ESTIMATE

HIKING AND RIDING TRAILS REGIONAL MULTI-PURPOSE

Deer Creek

Foothill Blvd. - Arrow Route (2,500 l.f.)

	<u>Item</u>	<u>Quantity</u>	<u>Unit Price</u>	<u>Total</u>
1.	Grading	30,000 S.F.	.40	12,000
2.	Decomposed Granite	30,000 S.F.	.50	15,000
3.	Signage	5 EA	130.00	650
4.	Fencing at Hazard Areas	N/A	-----	-----
5.	Lighting	N/A	-----	-----
6.	Undercrossings at Roads	N/A	-----	-----
TOTAL:				\$27,650

COST ESTIMATE

HIKING AND RIDING TRAILS REGIONAL MULTI-PURPOSE

Deer Creek

Arrow Route - 4th Street (7,500 l.f.)

	<u>Item</u>	<u>Quantity</u>	<u>Unit Price</u>	<u>Total</u>
1.	Grading	90,000 S.F.	.40	36,000
2.	Decomposed Granite	90,000 S.F.	.50	45,000
3.	Signage	12 EA	130.00	1,560
4.	Fencing at Hazard Areas	N/A	-----	-----
5.	Lighting	N/A	-----	-----
6.	Undercrossings at Roads	N/A	-----	-----
TOTAL:				\$82,560

COST ESTIMATE

HIKING AND RIDING TRAILS REGIONAL MULTI-PURPOSE

Day Creek

Rural Area N. of City Limit - N. City Limit (9,500 l.f.)

	<u>Item</u>	<u>Quantity</u>	<u>Unit Price</u>	<u>Total</u>
1.	Grading	114,000 S.F.	.40	45,600
2.	Decomposed Granite	114,000 S.F.	.50	57,000
3.	Signage	15 EA	130.00	1,950
4.	Fencing at Hazard Areas	N/A	-----	-----
5.	Lighting	49 EA	3,000.00	147,000
6.	Undercrossings at Roads	N/A	-----	-----
TOTAL:				<u>\$251,550</u>

COST ESTIMATE

HIKING AND RIDING TRAILS REGIONAL MULTI-PURPOSE

Day Creek

N. City Limit - Highland Avenue (7,000 l.f.)

	<u>Item</u>	<u>Quantity</u>	<u>Unit Price</u>	<u>Total</u>
1.	Grading	84,000 S.F.	.40	33,600
2.	Decomposed Granite	84,000 S.F.	.50	42,000
3.	Signage	12 EA	130.00	1,560
4.	Fencing at Hazard Areas	N/A	-----	-----
5.	Lighting	36 EA	3,000.00	108,000
6.	Undercrossings at Roads	2 EA	1,200,000.00	2,400,000
				<hr/>
			TOTAL:	\$2,585,160

COST ESTIMATE

HIKING AND RIDING TRAILS REGIONAL MULTI-PURPOSE

Day Creek

Highland Avenue - Base Line (5,000 l.f.)

	<u>Item</u>	<u>Quantity</u>	<u>Unit Price</u>	<u>Total</u>
1.	Grading	60,000 S.F.	.40	24,000
2.	Decomposed Granite	60,000 S.F.	.50	30,000
3.	Signage	9 EA	130.00	1,170
4.	Fencing at Hazard Areas	N/A	-----	-----
5.	Lighting	N/A	-----	-----
6.	Undercrossings at Roads	N/A	-----	-----
				<hr/>
			TOTAL:	\$55,170

COST ESTIMATE

HIKING AND RIDING TRAILS REGIONAL MULTI-PURPOSE

Day Creek

Base Line - Foothill Blvd. (5,000 l.f.)

	<u>Item</u>	<u>Quantity</u>	<u>Unit Price</u>	<u>Total</u>
1.	Grading	60,000 S.F.	.40	24,000
2.	Decomposed Granite	60,000 S.F.	.50	30,000
3.	Signage	9 EA	130.00	1,170
4.	Fencing at Hazard Areas	N/A	-----	-----
5.	Lighting	N/A	-----	-----
6.	Undercrossings at Roads	N/A	-----	-----
TOTAL:				\$55,170

COST ESTIMATE

HIKING AND RIDING TRAILS REGIONAL MULTI-PURPOSE

Day Creek

Foothill Blvd. - Arrow Route (2,500 l.f.)

	<u>Item</u>	<u>Quantity</u>	<u>Unit Price</u>	<u>Total</u>
1.	Grading	30,000 S.F.	.40	12,000
2.	Decomposed Granite	30,000 S.F.	.50	15,000
3.	Signage	5 EA	130.00	650
4.	Fencing at Hazard Areas	N/A	-----	-----
5.	Lighting	N/A	-----	-----
6.	Undercrossings at Roads	N/A	-----	-----
			TOTAL:	\$27,650

COST ESTIMATE

HIKING AND RIDING TRAILS REGIONAL MULTI-PURPOSE

Day Creek

Arrow Route - 4th Street (7,500 l.f.)

<u>Item</u>	<u>Quantity</u>	<u>Unit Price</u>	<u>Total</u>
1. Grading	90,000 S.F.	.40	36,000
2. Decomposed Granite	90,000 S.F.	.50	45,000
3. Signage	12 EA	130.00	1,560
4. Fencing at Hazard Areas	N/A	-----	-----
5. Lighting	N/A	-----	-----
6. Undercrossings at Roads	N/A	-----	-----
			<hr/>
		TOTAL:	\$82,560

COST ESTIMATE

HIKING AND RIDING TRAILS REGIONAL MULTI-PURPOSE

Frontline Regional Trail

W. City Limit - E. City Limit (29,000 l.f.)

	<u>Item</u>	<u>Quantity</u>	<u>Unit Price</u>	<u>Total</u>
1.	Grading	348,000 S.F.	.40	139,200
2.	Decomposed Granite	N/A	-----	-----
3.	Signage	20 EA	130.00	2,600
4.	Fencing at Hazard Areas	1,740	25.00	43,500
5.	Lighting	N/A	-----	-----
6.	Undercrossings at Roads	N/A	-----	-----
TOTAL:				\$185,300

COST ESTIMATE

HIKING AND RIDING TRAILS COMMUNITY TRAILS

Turquoise Avenue

Almond Street - Banyan Street (6,000 l.f.)

A. New Construction

<u>Item</u>	<u>Quantity</u>	<u>Unit Price</u>	<u>Total</u>
1. Land Acquisition	-----	-----	-----
2. Demolition	-----	-----	-----
3. Grading	72,000 S.F.	.40	28,800
4. Decomposed Granite Surface	72,000 S.F.	.50	36,000
5. Signage	10 EA	130.00	1,300
6. Fencing & Concrete Curb	12,000 L.F.	22.00	264,000
7. Bridges	-----	-----	-----
Sub-Total:			\$330,100

B. Demolition & Reconstruction

<u>Item</u>	<u>Quantity</u>	<u>Unit Price</u>	<u>Total</u>
1. Landscape Demolition	25,760 S.F.	.30	7,728
2. Concrete Demolition	3,520 S.F.	1.00	3,520
3. Wall Demolition	N/A	20.00	-----
4. Tree Removal	67 EA	300.00	20,100
5. New 3' High Retaining Wall	N/A	40.00	-----
Sub-Total:			\$31,348
20% Contingency			\$6,270
Sub-Total:			\$37,618
Budgeted Amount			\$37,500
TOTAL:			\$367,600

COST ESTIMATE

HIKING AND RIDING TRAILS COMMUNITY TRAILS

Sapphire Street

Almond Street - Banyan Street (6,000 l.f.)

A. New Construction

<u>Item</u>	<u>Quantity</u>	<u>Unit Price</u>	<u>Total</u>
1. Land Acquisition	-----	-----	-----
2. Demolition	-----	-----	-----
3. Grading	72,000 S.F.	.40	28,800
4. Decomposed Granite Surface	72,000 S.F.	.50	36,000
5. Signage	10 EA	130.00	1,300
6. Fencing & Concrete Curb	9,636 L.F.	22.00	212,000
7. Bridges	-----	-----	-----
Sub-Total:			\$278,100

B. Demolition & Reconstruction

<u>Item</u>	<u>Quantity</u>	<u>Unit Price</u>	<u>Total</u>
1. Landscape Demolition	12,160 S.F.	.30	3,648
2. Concrete Demolition	3,200 S.F.	1.00	3,200
3. Wall Demolition	N/A	20.00	-----
4. Tree Removal	23 EA	300.00	6,900
5. New 3' High Retaining Wall	N/A	40.00	-----
Sub-Total:			\$13,748
20% Contingency			\$2,750
Sub-Total:			\$16,498
Budgeted Amount			\$16,500
TOTAL:			\$294,600

COST ESTIMATE

HIKING AND RIDING TRAILS COMMUNITY TRAILS

Topaz Channel (4,000 l.f.)

	<u>Item</u>	<u>Quantity</u>	<u>Unit Price</u>	<u>Total</u>
1.	Land Acquisition	-----	-----	-----
2.	Demolition	-----	-----	-----
3.	Grading	48,000 S.F.	.40	19,200
4.	Decomposed Granite Surface	48,000 S.F.	.50	24,000
5.	Signage	7 EA	130.00	910
6.	Fencing & Concrete Curb	6,682 L.F.	22.00	147,000
7.	Bridges	-----	-----	-----
				<hr/>
			TOTAL:	\$191,110

COST ESTIMATE

HIKING AND RIDING TRAILS COMMUNITY TRAILS

Carnelian Street

Almond - Banyan Street (6,000 l.f.)

A. New Construction

<u>Item</u>	<u>Quantity</u>	<u>Unit Price</u>	<u>Total</u>
1. Land Acquisition	-----	-----	-----
2. Demolition	-----	-----	-----
3. Grading	72,000 S.F.	.40	28,800
4. Decomposed Granite Surface	72,000 S.F.	.50	36,000
5. Signage	10 EA	130.00	1,300
6. Fencing & Concrete Curb	6,682 L.F.	22.00	147,000
7. Bridges	-----	-----	-----
Sub-Total:			\$213,100

B. Demolition & Reconstruction

<u>Item</u>	<u>Quantity</u>	<u>Unit Price</u>	<u>Total</u>
1. Landscape Demolition	23,680 S.F.	.30	7,104
2. Concrete Demolition	8,000 S.F.	1.00	8,000
3. Wall Demolition	N/A	20.00	-----
4. Tree Removal	56 EA	300.00	16,800
5. New 3' High Retaining Wall	80 L.F.	40.00	3,200
			\$35,104
20% Contingency			\$7,021
Sub-Total:			\$42,125
Budgeted Amount			\$42,000
TOTAL:			\$255,100

COST ESTIMATE

HIKING AND RIDING TRAILS COMMUNITY TRAILS

Beryl Street

Reales Street - Banyan Street (6,000 l.f.)

A. New Construction

<u>Item</u>	<u>Quantity</u>	<u>Unit Price</u>	<u>Total</u>
1. Land Acquisition	-----	-----	-----
2. Demolition	-----	-----	-----
3. Grading	72,000 S.F.	.40	28,800
4. Decomposed Granite Surface	72,000 S.F.	.50	36,000
5. Signage	10 EA	130.00	1,300
6. Fencing & Concrete Curb	6,409 L.F.	22.00	141,000
7. Bridges	-----	-----	-----
Sub-Total:			\$207,100

B. Demolition & Reconstruction

<u>Item</u>	<u>Quantity</u>	<u>Unit Price</u>	<u>Total</u>
1. Landscape Demolition	N/A	.30	-----
2. Concrete Demolition	N/A	1.00	-----
3. Wall Demolition	400 L.F.	20.00	8,000
4. Tree Removal	N/A	300.00	-----
5. New 3' High Retaining Wall	N/A	40.00	-----
			\$8,000
20% Contingency			\$1,600
Sub-Total:			\$9,600
Budgeted Amount			\$9,500
TOTAL:			\$216,600

COST ESTIMATE

HIKING AND RIDING TRAILS COMMUNITY TRAILS

Amethyst Street

Almond Street - Banyan Street (6,000 l.f.)

A. New Construction

<u>Item</u>	<u>Quantity</u>	<u>Unit Price</u>	<u>Total</u>
1. Land Acquisition	-----	-----	-----
2. Demolition	-----	-----	-----
3. Grading	72,000 S.F.	.40	28,800
4. Decomposed Granite Surface	72,000 S.F.	.50	36,000
5. Signage	10 EA	130.00	1,300
6. Fencing & Concrete Curb	12,000 L.F.	22.00	264,000
7. Bridges	-----	-----	-----
Sub-Total:			\$330,100

B. Demolition & Reconstruction

<u>Item</u>	<u>Quantity</u>	<u>Unit Price</u>	<u>Total</u>
1. Landscape Demolition	27,840 S.F.	.30	8,352
2. Concrete Demolition	2,400 S.F.	1.00	2,400
3. Wall Demolition	80 L.F.	20.00	1,600
4. Tree Removal	75 EA	300.00	22,500
5. New 3' High Retaining Wall	N/A	40.00	-----
20% Contingency			\$34,852
Sub-Total:			\$41,822
Budgeted Amount			\$42,000
TOTAL:			\$372,100

COST ESTIMATE

HIKING AND RIDING TRAILS COMMUNITY TRAILS

Archibald Street

Frontline Regional Trail (Rural Area) - Banyan Street (8,500 l.f.)

A. New Construction

<u>Item</u>	<u>Quantity</u>	<u>Unit Price</u>	<u>Total</u>
1. Land Acquisition	-----	-----	-----
2. Demolition	-----	-----	-----
3. Grading	102,000 S.F.	.40	40,800
4. Decomposed Granite Surface	102,000 S.F.	.50	51,000
5. Signage	14 EA	130.00	1,820
6. Fencing & Concrete Curb	10,364 L.F.	22.00	228,000
7. Bridges	-----	-----	-----
Sub-Total:			\$321,620

B. Demolition & Reconstruction

<u>Item</u>	<u>Quantity</u>	<u>Unit Price</u>	<u>Total</u>
1. Landscape Demolition	21,280 S.F.	.30	6,384
2. Concrete Demolition	800 S.F.	1.00	800
3. Wall Demolition	200 L.F.	20.00	4,000
4. Tree Removal	52 EA	300.00	15,600
5. New 3' High Retaining Wall	80 L.F.	40.00	3,200
			\$29,984
20% Contingency			\$5,997
Sub-Total:			\$35,981
Budgeted Amount			\$36,000
TOTAL:			\$357,620

COST ESTIMATE

HIKING AND RIDING TRAILS COMMUNITY TRAILS

Alta Loma Storm Drain Channel
Almond Trail - Banyan Street (6,500 l.f.)

<u>Item</u>	<u>Quantity</u>	<u>Unit Price</u>	<u>Total</u>
1. Land Acquisition	-----	-----	-----
2. Demolition	-----	-----	-----
3. Grading	78,000 S.F.	.40	31,200
4. Decomposed Granite Surface	78,000 S.F.	.50	39,000
5. Signage	11 EA	130.00	1,430
6. Fencing & Concrete Curb	227 L.F.	22.00	5,000
7. Bridges	1 EA	25,000.00	25,000
			<hr/>
		TOTAL:	\$101,630

COST ESTIMATE

HIKING AND RIDING TRAILS COMMUNITY TRAILS

Hermosa Avenue

Almond Street - Banyan Street (West Side) (6,000 l.f.)

A. New Construction

<u>Item</u>	<u>Quantity</u>	<u>Unit Price</u>	<u>Total</u>
1. Land Acquisition	-----	-----	-----
2. Demolition	-----	-----	-----
3. Grading	72,000 S.F.	.40	28,800
4. Decomposed Granite Surface	72,000 S.F.	.50	36,000
5. Signage	10 EA	130.00	1,300
6. Fencing & Concrete Curb	6,136 L.F.	22.00	135,000
7. Bridges	-----	-----	-----
			<hr/>
	Sub-Total:		\$201,100

B. Demolition & Reconstruction

<u>Item</u>	<u>Quantity</u>	<u>Unit Price</u>	<u>Total</u>
1. Landscape Demolition	960 S.F.	.30	288
2. Concrete Demolition	480 S.F.	1.00	480
3. Wall Demolition	N/A	20.00	-----
4. Tree Removal	30 EA	300.00	9,000
5. New 3' High Retaining Wall	N/A	40.00	-----
			<hr/>
			\$9,768
20% Contingency			\$1,954
			<hr/>
	Sub-Total:		\$11,722
			<hr/>
Budgeted Amount			\$11,500
			<hr/>
	TOTAL:		\$212,600

COST ESTIMATE

HIKING AND RIDING TRAILS COMMUNITY TRAILS

Haven Avenue

Tackstem Street - Flood Control Basin (North Side) (2,000 l.f.)

A. New Construction

	<u>Item</u>	<u>Quantity</u>	<u>Unit Price</u>	<u>Total</u>
1.	Land Acquisition	-----	-----	-----
2.	Demolition	-----	-----	-----
3.	Grading	24,000 S.F.	.40	9,600
4.	Decomposed Granite Surface	24,000 S.F.	.50	12,000
5.	Signage	4 EA	130.00	520
6.	Fencing & Concrete Curb	4,545 L.F.	22.00	100,000
7.	Bridges	-----	-----	-----

Sub-Total: \$122,120

B. Demolition & Reconstruction

	<u>Item</u>	<u>Quantity</u>	<u>Unit Price</u>	<u>Total</u>
1.	Landscape Demolition	32,840 S.F.	.30	9,852
2.	Concrete Demolition	8,560 S.F.	1.00	8,560
3.	Wall Demolition	N/A	20.00	-----
4.	Tree Removal	30 EA	300.00	9,000
5.	New 3' High Retaining Wall	N/A	40.00	-----

\$27,412

20% Contingency

\$5,482

Sub-Total: \$32,894

Budgeted Amount

\$33,000

TOTAL: \$155,120

COST ESTIMATE

HIKING AND RIDING TRAILS COMMUNITY TRAILS

Haven Avenue

Flood Control Basin (North Side) - Banyan Street (5,500 l.f.)

	<u>Item</u>	<u>Quantity</u>	<u>Unit Price</u>	<u>Total</u>
1.	Land Acquisition	.04 ACRE	100,000.00	4,000
2.	Demolition	-----	-----	-----
3.	Grading	66,000 S.F.	.40	26,400
4.	Decomposed Granite Surface	66,000 S.F.	.50	33,000
5.	Signage	9 EA	130.00	1,170
6.	Fencing & Concrete Curb	6,273 L.F.	22.00	138,000
7.	Bridges	-----	-----	-----
TOTAL:				\$202,570

COST ESTIMATE
HIKING AND RIDING TRAILS
COMMUNITY TRAILS

Etiwanda Avenue
 24th Street - Highland Avenue (5,000 l.f.)

	<u>Item</u>	<u>Quantity</u>	<u>Unit Price</u>	<u>Total</u>
1.	Land Acquisition	-----	-----	-----
2.	Demolition	-----	-----	-----
3.	Grading	60,000 S.F.	.40	24,000
4.	Decomposed Granite Surface	60,000 S.F.	.50	30,000
5.	Signage	9 EA	130.00	1,170
6.	Fencing & Concrete Curb	10,000 L.F.	22.00	220,000
7.	Bridges	-----	-----	-----
TOTAL:				\$275,170

COST ESTIMATE

HIKING AND RIDING TRAILS COMMUNITY TRAILS

Choctaw Place

24th Street - Arapaho Road (3,500 l.f.)

	<u>Item</u>	<u>Quantity</u>	<u>Unit Price</u>	<u>Total</u>
1.	Land Acquisition	-----	-----	-----
2.	Demolition	-----	-----	-----
3.	Grading	42,000 S.F.	.40	16,800
4.	Decomposed Granite Surface	42,000 S.F.	.50	21,000
5.	Signage	6 EA	130.00	780
6.	Fencing & Concrete Curb	7,000 L.F.	22.00	154,000
7.	Bridges	-----	-----	-----
				<hr/>
			TOTAL:	\$192,580

COST ESTIMATE

HIKING AND RIDING TRAILS COMMUNITY TRAILS

Street "C"

24th Street - Arapaho Road (3,500 l.f.)

	<u>Item</u>	<u>Quantity</u>	<u>Unit Price</u>	<u>Total</u>
1.	Land Acquisition	-----	-----	-----
2.	Demolition	-----	-----	-----
3.	Grading	42,000 S.F.	.40	16,800
4.	Decomposed Granite Surface	42,000 S.F.	.50	21,000
5.	Signage	6 EA	130.00	780
6.	Fencing & Concrete Curb	7,000 L.F.	22.00	154,000
7.	Bridges	-----	-----	-----
				<hr/>
			TOTAL:	\$192,580

COST ESTIMATE

HIKING AND RIDING TRAILS COMMUNITY TRAILS

Wardman Bullock Road

24th Street - Highland Avenue (5,000 l.f.)

	<u>Item</u>	<u>Quantity</u>	<u>Unit Price</u>	<u>Total</u>
1.	Land Acquisition	-----	-----	-----
2.	Demolition	-----	-----	-----
3.	Grading	60,000 S.F.	.40	24,000
4.	Decomposed Granite Surface	60,000 S.F.	.50	30,000
5.	Signage	9 EA	130.00	1,170
6.	Fencing & Concrete Curb	10,000 L.F.	22.00	220,000
7.	Bridges	-----	-----	-----
				<hr/>
			TOTAL:	\$275,170

COST ESTIMATE

HIKING AND RIDING TRAILS COMMUNITY TRAILS

Wardman Bullock Road

Highland Avenue - Devore Freeway (1,500 l.f.)

	<u>Item</u>	<u>Quantity</u>	<u>Unit Price</u>	<u>Total</u>
1.	Land Acquisition	-----	-----	-----
2.	Demolition	-----	-----	-----
3.	Grading	18,000 S.F.	.40	7,200
4.	Decomposed Granite Surface	18,000 S.F.	.50	9,000
5.	Signage	3 EA	130.00	390
6.	Fencing & Concrete Curb	3,000 L.F.	22.00	66,000
7.	Bridges	-----	-----	-----
				<hr/>
			TOTAL:	\$82,590

COST ESTIMATE

HIKING AND RIDING TRAILS COMMUNITY TRAILS

Wardman Bullock Road

Devore Freeway - Southern Pacific Railroad (3,000 l.f.)

<u>Item</u>	<u>Quantity</u>	<u>Unit Price</u>	<u>Total</u>
1. Land Acquisition	-----	-----	-----
2. Demolition	-----	-----	-----
3. Grading	36,000 S.F.	.40	14,400
4. Decomposed Granite Surface	36,000 S.F.	.50	18,000
5. Signage	6 EA	130.00	780
6. Fencing & Concrete Curb	6,000 L.F.	22.00	132,000
7. Bridges	-----	-----	-----
			<hr/>
		TOTAL:	\$165,180

COST ESTIMATE

HIKING AND RIDING TRAILS COMMUNITY TRAILS

Loop

24th Street - Devore Freeway (5,000 l.f.)

	<u>Item</u>	<u>Quantity</u>	<u>Unit Price</u>	<u>Total</u>
1.	Land Acquisition	-----	-----	-----
2.	Demolition	-----	-----	-----
3.	Grading	60,000 S.F.	.40	24,000
4.	Decomposed Granite Surface	60,000 S.F.	.50	30,000
5.	Signage	9 EA	130.00	1,170
6.	Fencing & Concrete Curb	10,000 L.F.	22.00	220,000
7.	Bridges	-----	-----	-----
				<hr/>
			TOTAL:	\$275,170

COST ESTIMATE

HIKING AND RIDING TRAILS COMMUNITY TRAILS

San Sevaine Basin Trail
24th Street - Loop (2,500 l.f.)

<u>Item</u>	<u>Quantity</u>	<u>Unit Price</u>	<u>Total</u>
1. Land Acquisition	-----	-----	-----
2. Demolition	-----	-----	-----
3. Grading	30,000 S.F.	.40	12,000
4. Decomposed Granite Surface	30,000 S.F.	.50	15,000
5. Signage	5 EA	130.00	650
6. Fencing & Concrete Curb	5,000 L.F.	22.00	110,000
7. Bridges	-----	-----	-----
			<hr/>
		TOTAL:	\$137,650

COST ESTIMATE

**HIKING AND RIDING TRAILS
COMMUNITY TRAILS**

Tract 13027 Trail

Trail "E" - Kalmia Street

DEVELOPED AND DEDICATED

COST ESTIMATE

HIKING AND RIDING TRAILS COMMUNITY TRAILS

Tipu Place

Victoria Windrows N. - Southern Pacific Railroad (1,400 l.f.)

<u>Item</u>	<u>Quantity</u>	<u>Unit Price</u>	<u>Total</u>
1. Land Acquisition	-----	-----	-----
2. Demolition	-----	-----	-----
3. Grading	16,800 S.F.	.40	6,720
4. Decomposed Granite Surface	16,800 S.F.	.50	8,400
5. Signage	3 EA	130.00	390
6. Fencing & Concrete Curb	2,800 L.F.	22.00	61,600
7. Bridges	-----	-----	-----
			<hr/>
		TOTAL:	\$77,110

COST ESTIMATE
HIKING AND RIDING TRAILS
COMMUNITY TRAILS

COST ESTIMATE
HIKING AND RIDING TRAILS
COMMUNITY TRAILS

COST ESTIMATE
HIKING AND RIDING TRAILS
COMMUNITY TRAILS

COST ESTIMATE

HIKING AND RIDING TRAILS COMMUNITY TRAILS

Cornwall Trail (SCE Corridor)
East Avenue - Foothill Blvd. (2,500 l.f.)

<u>Item</u>	<u>Quantity</u>	<u>Unit Price</u>	<u>Total</u>
1. Land Acquisition	-----	-----	-----
2. Demolition	-----	-----	-----
3. Grading	30,000 S.F.	.40	12,000
4. Decomposed Granite Surface	30,000 S.F.	.50	15,000
5. Signage	5 EA	130.00	650
6. Fencing & Concrete Curb	5,000 L.F.	22.00	110,000
7. Bridges	-----	-----	-----
			<hr/>
		TOTAL:	\$137,650

COST ESTIMATE

HIKING AND RIDING TRAILS COMMUNITY TRAILS

Cornwall Trail (SCE Corridor)

Foothill Blvd. - Arrow Route (1,500 l.f.)

<u>Item</u>	<u>Quantity</u>	<u>Unit Price</u>	<u>Total</u>
1. Land Acquisition	-----	-----	-----
2. Demolition	-----	-----	-----
3. Grading	18,000 S.F.	.40	7,200
4. Decomposed Granite Surface	18,000 S.F.	.50	9,000
5. Signage	3 EA	130.00	390
6. Fencing & Concrete Curb	3,000 L.F.	22.00	66,000
7. Bridges	-----	-----	-----
			<hr/>
		TOTAL:	\$82,590

COST ESTIMATE

HIKING AND RIDING TRAILS COMMUNITY TRAILS

Almond Trail

Cucamonga Creek - Sapphire Street (1,500 l.f)

	<u>Item</u>	<u>Quantity</u>	<u>Unit Price</u>	<u>Total</u>
1.	Land Acquisition	-----	-----	-----
2.	Demolition	-----	-----	-----
3.	Grading	18,000 S.F.	.40	7,200
4.	Decomposed Granite Surface	18,000 S.F.	.50	9,000
5.	Signage	3 EA	130.00	390
6.	Fencing & Concrete Curb	3,000 L.F.	22.00	66,000
7.	Bridges	-----	-----	-----
				<hr/>
			TOTAL:	\$82,590

COST ESTIMATE

HIKING AND RIDING TRAILS COMMUNITY TRAILS

Almond Trail

Sapphire Street - Carnelian Street (2,500 l.f.)

	<u>Item</u>	<u>Quantity</u>	<u>Unit Price</u>	<u>Total</u>
1.	Land Acquisition	-----	-----	-----
2.	Demolition	-----	-----	-----
3.	Grading	30,000 S.F.	.40	12,000
4.	Decomposed Granite Surface	30,000 S.F.	.50	15,000
5.	Signage	5 EA	130.00	650
6.	Fencing & Concrete Curb	5,000 L.F.	22.00	110,000
7.	Bridges	-----	-----	-----
				<hr/>
			TOTAL:	\$137,650

COST ESTIMATE

HIKING AND RIDING TRAILS COMMUNITY TRAILS

Almond Trail

Carnelian Street - Beryl Street (Reales Street) (2,500 l.f.)

	<u>Item</u>	<u>Quantity</u>	<u>Unit Price</u>	<u>Total</u>
1.	Land Acquisition	.23 ACRE	100,000.00	23,000
2.	Demolition	-----	-----	-----
3.	Grading	30,000 S.F.	.40	12,000
4.	Decomposed Granite Surface	30,000 S.F.	.50	15,000
5.	Signage	5 EA	130.00	650
6.	Fencing & Concrete Curb	5,000 L.F.	22.00	110,000
7.	Bridges	-----	-----	-----
TOTAL:				\$160,650

COST ESTIMATE

HIKING AND RIDING TRAILS COMMUNITY TRAILS

Almond Trail

Beryl Street - Amethyst Avenue (1,500 l.f.)

	<u>Item</u>	<u>Quantity</u>	<u>Unit Price</u>	<u>Total</u>
1.	Land Acquisition	-----	-----	-----
2.	Demolition	-----	-----	-----
3.	Grading	18,000 S.F.	.40	7,200
4.	Decomposed Granite Surface	18,000 S.F.	.50	9,000
5.	Signage	3 EA	130.00	390
6.	Fencing & Concrete Curb	3,000 L.F.	22.00	66,000
7.	Bridges	-----	-----	-----
TOTAL:				\$82,590

COST ESTIMATE

HIKING AND RIDING TRAILS COMMUNITY TRAILS

Almond Trail

Amethyst Avenue - Archibald Avenue (2,000 l.f.)

	<u>Item</u>	<u>Quantity</u>	<u>Unit Price</u>	<u>Total</u>
1.	Land Acquisition	-----	-----	-----
2.	Demolition	-----	-----	-----
3.	Grading	24,000 S.F.	.40	9,600
4.	Decomposed Granite Surface	24,000 S.F.	.50	12,000
5.	Signage	4 EA	130.00	520
6.	Fencing & Concrete Curb	4,000 L.F.	22.00	88,000
7.	Bridges	-----	-----	-----
				<hr/>
			TOTAL:	\$110,120

COST ESTIMATE

HIKING AND RIDING TRAILS COMMUNITY TRAILS

Almond Trail

Archibald Avenue - Hermosa Avenue (3,000 l.f.)

	<u>Item</u>	<u>Quantity</u>	<u>Unit Price</u>	<u>Total</u>
1.	Land Acquisition	-----	-----	-----
2.	Demolition	-----	-----	-----
3.	Grading	36,000 S.F.	.40	14,400
4.	Decomposed Granite Surface	36,000 S.F.	.50	18,000
5.	Signage	6 EA	130.00	780
6.	Fencing & Concrete Curb	6,000 L.F.	22.00	132,000
7.	Bridges	-----	-----	-----
				<hr/>
			TOTAL:	\$165,180

COST ESTIMATE

HIKING AND RIDING TRAILS COMMUNITY TRAILS

Almond Trail

Hermosa Avenue - Hillside Channel (2,000 l.f.)

<u>Item</u>	<u>Quantity</u>	<u>Unit Price</u>	<u>Total</u>
1. Land Acquisition	-----	-----	-----
2. Demolition	-----	-----	-----
3. Grading	24,000 S.F.	.40	9,600
4. Decomposed Granite Surface	24,000 S.F.	.50	12,000
5. Signage	4 EA	130.00	520
6. Fencing & Concrete Curb	4,000 L.F.	22.00	88,000
7. Bridges	-----	-----	-----
TOTAL:			\$110,120

COST ESTIMATE

HIKING AND RIDING TRAILS COMMUNITY TRAILS

Hillside Road

Cucamonga Creek - Sapphire Street (3,000 l.f.)

A. New Construction

<u>Item</u>	<u>Quantity</u>	<u>Unit Price</u>	<u>Total</u>
1. Land Acquisition	.10 ACRE	100,000.00	10,000
2. Demolition	-----	-----	-----
3. Grading	36,000 S.F.	.40	14,400
4. Decomposed Granite Surface	36,000 S.F.	.50	18,000
5. Signage	6 EA	130.00	780
6. Fencing & Concrete Curb	6,000 L.F.	22.00	132,000
7. Bridges	-----	-----	-----
Sub-Total:			\$175,180

B. Demolition & Reconstruction

<u>Item</u>	<u>Quantity</u>	<u>Unit Price</u>	<u>Total</u>
1. Landscape Demolition	7,680 S.F.	.30	2,304
2. Concrete Demolition	N/A	1.00	-----
3. Wall Demolition	N/A	20.00	-----
4. Tree Removal	17 EA	300.00	5,100
5. New 3' High Retaining Wall	N/A	40.00	-----
			\$7,404
20% Contingency			\$1,480
Sub-Total:			\$8,884
Budgeted Amount			\$9,000
TOTAL:			\$184,180

COST ESTIMATE

HIKING AND RIDING TRAILS COMMUNITY TRAILS

Hillside Road

Sapphire Street - Carnelian Street (3,000 l.f.)

A. New Construction

<u>Item</u>	<u>Quantity</u>	<u>Unit Price</u>	<u>Total</u>
1. Land Acquisition	.18 ACRE	100,000.00	18,000
2. Demolition	-----	-----	-----
3. Grading	36,000 S.F.	.40	14,400
4. Decomposed Granite Surface	36,000 S.F.	.50	18,000
5. Signage	6 EA	130.00	780
6. Fencing & Concrete Curb	6,000 L.F.	22.00	132,000
7. Bridges	-----	-----	-----

Sub-Total: \$183,180

B. Demolition & Reconstruction

<u>Item</u>	<u>Quantity</u>	<u>Unit Price</u>	<u>Total</u>
1. Landscape Demolition	20,880 S.F.	.30	6,264
2. Concrete Demolition	1,920 S.F.	1.00	1,920
3. Wall Demolition	N/A	20.00	-----
4. Tree Removal	21 EA	300.00	6,300
5. New 3' High Retaining Wall	120 L.F.	40.00	4,800

\$19,284

20% Contingency

\$3,857

Sub-Total: \$23,141

Budgeted Amount

\$23,000

TOTAL: \$206,180

COST ESTIMATE

HIKING AND RIDING TRAILS COMMUNITY TRAILS

Hillside Road

Carnelian Street - Hellman Avenue (3,500 l.f.)

A. New Construction

	<u>Item</u>	<u>Quantity</u>	<u>Unit Price</u>	<u>Total</u>
1.	Land Acquisition	.12 ACRE	100,000.00	12,000
2.	Demolition	-----	-----	-----
3.	Grading	42,000 S.F.	.40	16,800
4.	Decomposed Granite Surface	42,000 S.F.	.50	21,000
5.	Signage	6 EA	130.00	780
6.	Fencing & Concrete Curb	7,000 L.F.	22.00	154,000
7.	Bridges	-----	-----	-----
				<hr/>
Sub-Total:				\$204,580

B. Demolition & Reconstruction

	<u>Item</u>	<u>Quantity</u>	<u>Unit Price</u>	<u>Total</u>
1.	Landscape Demolition	7,080 S.F.	.30	2,124
2.	Concrete Demolition	N/A	1.00	-----
3.	Wall Demolition	N/A	20.00	-----
4.	Tree Removal	8 EA	300.00	2,400
5.	New 3' High Retaining Wall	200 L.F.	40.00	8,000
				<hr/>
				\$12,524
20% Contingency				\$2,505
				<hr/>
Sub-Total:				\$15,029
Budgeted Amount				\$15,000
				<hr/>
TOTAL:				\$219,580

COST ESTIMATE

HIKING AND RIDING TRAILS COMMUNITY TRAILS

Hillside Road

Hellman Avenue - Archibald Avenue (3,000 l.f.)

A. New Construction

<u>Item</u>	<u>Quantity</u>	<u>Unit Price</u>	<u>Total</u>
1. Land Acquisition	.09 ACRE	100,000.00	9,000
2. Demolition	-----	-----	-----
3. Grading	36,000 S.F.	.40	14,400
4. Decomposed Granite Surface	36,000 S.F.	.50	18,000
5. Signage	6 EA	130.00	780
6. Fencing & Concrete Curb	6,000 L.F.	22.00	132,000
7. Bridges	-----	-----	-----
Sub-Total:			\$174,180

B. Demolition & Reconstruction

<u>Item</u>	<u>Quantity</u>	<u>Unit Price</u>	<u>Total</u>
1. Landscape Demolition	12,240 S.F.	.30	3,672
2. Concrete Demolition	N/A	1.00	-----
3. Wall Demolition	N/A	20.00	-----
4. Tree Removal	N/A	300.00	-----
5. New 3' High Retaining Wall	N/A	40.00	-----
			\$3,672
20% Contingency			\$734
Sub-Total:			\$4,406
Budgeted Amount			\$4,500
TOTAL:			\$178,680

COST ESTIMATE

HIKING AND RIDING TRAILS COMMUNITY TRAILS

Hillside Road

Archibald Avenue - Hermosa Avenue (2,500 l.f.)

A. New Construction

<u>Item</u>	<u>Quantity</u>	<u>Unit Price</u>	<u>Total</u>
1. Land Acquisition	.05 ACRE	100,000.00	5,000
2. Demolition	-----	-----	-----
3. Grading	30,000 S.F.	.40	12,000
4. Decomposed Granite Surface	30,000 S.F.	.50	15,000
5. Signage	5 EA	130.00	650
6. Fencing & Concrete Curb	5,000 L.F.	22.00	110,000
7. Bridges		-----	-----

Sub-Total: \$142,650

B. Demolition & Reconstruction

<u>Item</u>	<u>Quantity</u>	<u>Unit Price</u>	<u>Total</u>
1. Landscape Demolition	1,800 S.F.	.30	540
2. Concrete Demolition	N/A	1.00	-----
3. Wall Demolition	N/A	20.00	-----
4. Tree Removal	10 EA	300.00	3,000
5. New 3' High Retaining Wall	N/A	40.00	-----

\$3,540

20% Contingency

\$708

Sub-Total: \$4,248

Budgeted Amount

\$4,500

TOTAL: \$147,150

COST ESTIMATE

HIKING AND RIDING TRAILS COMMUNITY TRAILS

Hillside Road

Hermosa Avenue - Haven Avenue (2,500 l.f.)

A. New Construction

	<u>Item</u>	<u>Quantity</u>	<u>Unit Price</u>	<u>Total</u>
1.	Land Acquisition	.09 ACRE	100,000.00	9,000
2.	Demolition	-----	-----	-----
3.	Grading	30,000 S.F.	.40	12,000
4.	Decomposed Granite Surface	30,000 S.F.	.50	15,000
5.	Signage	5 EA	130.00	650
6.	Fencing & Concrete Curb	5,000 L.F.	22.00	110,000
7.	Bridges	-----	-----	-----
				<hr/>
Sub-Total:				\$146,650

B. Demolition & Reconstruction

	<u>Item</u>	<u>Quantity</u>	<u>Unit Price</u>	<u>Total</u>
1.	Landscape Demolition	6,720 S.F.	.30	2,016
2.	Concrete Demolition	N/A	1.00	-----
3.	Wall Demolition	40 L.F.	20.00	800
4.	Tree Removal	3 EA	300.00	900
5.	New 3' High Retaining Wall	160 L.F.	40.00	6,400
				<hr/>
				\$10,116
20% Contingency				\$2,023
				<hr/>
Sub-Total:				\$12,139
Budgeted Amount				\$12,000
				<hr/>
TOTAL:				\$158,650

COST ESTIMATE

HIKING AND RIDING TRAILS COMMUNITY TRAILS

Hillside Road

Haven Avenue - Deer Creek (4,500 l.f.)

A. New Construction

<u>Item</u>	<u>Quantity</u>	<u>Unit Price</u>	<u>Total</u>
1. Land Acquisition	-----	-----	-----
2. Demolition	-----	-----	-----
3. Grading	54,000 S.F.	.40	21,600
4. Decomposed Granite Surface	54,000 S.F.	.50	27,000
5. Signage	8 EA	130.00	1,040
6. Fencing & Concrete Curb	9,000 L.F.	22.00	198,000
7. Bridges	-----	-----	-----

Sub-Total: \$247,640

B. Demolition & Reconstruction

<u>Item</u>	<u>Quantity</u>	<u>Unit Price</u>	<u>Total</u>
1. Landscape Demolition	54,000 S.F.	.30	16,200
2. Concrete Demolition	N/A	1.00	-----
3. Wall Demolition	N/A	20.00	-----
4. Tree Removal	N/A	300.00	-----
5. New 3' High Retaining Wall	N/A	40.00	-----

\$16,200

20% Contingency

\$3,240

Sub-Total: \$19,440

Budgeted Amount

\$19,500

TOTAL: \$267,140

COST ESTIMATE

HIKING AND RIDING TRAILS COMMUNITY TRAILS

Wilson Trail

Cucamonga Creek - Sapphire Street (3,000 l.f.)

A. New Construction

<u>Item</u>	<u>Quantity</u>	<u>Unit Price</u>	<u>Total</u>
1. Land Acquisition	1.24 ACRE	100,000.00	124,000
2. Demolition	-----	-----	-----
3. Grading	36,000 S.F.	.40	14,400
4. Decomposed Granite Surface	36,000 S.F.	.50	18,000
5. Signage	6 EA	130.00	780
6. Fencing & Concrete Curb	6,000 L.F.	22.00	132,000
7. Bridges	-----	-----	-----
Sub-Total:			\$289,180

B. Demolition & Reconstruction

<u>Item</u>	<u>Quantity</u>	<u>Unit Price</u>	<u>Total</u>
1. Landscape Demolition	3,600 S.F.	.30	1,080
2. Concrete Demolition	N/A	1.00	-----
3. Wall Demolition	N/A	20.00	-----
4. Tree Removal	5 EA	300.00	1,500
5. New 3' High Retaining Wall	N/A	40.00	-----
			\$2,580
20% Contingency			\$516
Sub-Total:			\$3,096
Budgeted Amount			\$3,000
TOTAL:			\$292,180

COST ESTIMATE

HIKING AND RIDING TRAILS COMMUNITY TRAILS

Wilson Trail

Sapphire Street - Carnelian Street (1,500 l.f.)

A. New Construction

	<u>Item</u>	<u>Quantity</u>	<u>Unit Price</u>	<u>Total</u>
1.	Land Acquisition	.69 ACRE	100,000.00	69,000
	Lot Purchase (5706 Jasper)	1 EA	200,000.00	200,000
2.	Demolition	-----	-----	-----
3.	Grading	18,000 S.F.	.40	7,200
4.	Decomposed Granite Surface	18,000 S.F.	.50	9,000
5.	Signage	3 EA	130.00	390
6.	Fencing & Concrete Curb	3,000 L.F.	22.00	66,000
7.	Bridges	1 EA	25,000.00	25,000

Sub-Total: \$376,590

B. Demolition & Reconstruction

	<u>Item</u>	<u>Quantity</u>	<u>Unit Price</u>	<u>Total</u>
1.	Landscape Demolition	1,800 S.F.	.30	540
2.	Concrete Demolition	N/A	1.00	-----
3.	Wall Demolition	N/A	20.00	-----
4.	Tree Removal	N/A	300.00	-----
5.	New 3' High Retaining Wall	N/A	40.00	-----

\$540

20% Contingency

\$108

Sub-Total: \$648

Budgeted Amount

\$1,000

TOTAL: \$377,590

COST ESTIMATE

HIKING AND RIDING TRAILS COMMUNITY TRAILS

Wilson Trail

Carnelian Street - Beryl Street (2,500 l.f.)

A. New Construction

<u>Item</u>	<u>Quantity</u>	<u>Unit Price</u>	<u>Total</u>
1. Land Acquisition	-----	-----	-----
2. Demolition	-----	-----	-----
3. Grading	30,000 S.F.	.40	12,000
4. Decomposed Granite Surface	30,000 S.F.	.50	15,000
5. Signage	5 EA	130.00	650
6. Fencing & Concrete Curb	4,500 L.F.	22.00	99,000
7. Bridges	-----	-----	-----
Sub-Total:			\$126,650

B. Demolition & Reconstruction

<u>Item</u>	<u>Quantity</u>	<u>Unit Price</u>	<u>Total</u>
1. Landscape Demolition	16,000 S.F.	.30	4,800
2. Concrete Demolition	8,000 S.F.	1.00	8,000
3. Wall Demolition	N/A	20.00	-----
4. Tree Removal	N/A	300.00	-----
5. New 3' High Retaining Wall	N/A	40.00	-----
20% Contingency			\$12,800 \$2,560
Sub-Total:			\$15,360
Budgeted Amount			\$15,500
TOTAL:			\$142,150

COST ESTIMATE

HIKING AND RIDING TRAILS COMMUNITY TRAILS

Wilson Trail

Beryl Street - Hellman Avenue (1,000 l.f.)

	<u>Item</u>	<u>Quantity</u>	<u>Unit Price</u>	<u>Total</u>
1.	Land Acquisition	-----	-----	-----
2.	Demolition	-----	-----	-----
3.	Grading	12,000 S.F.	.40	4,800
4.	Decomposed Granite Surface	12,000 S.F.	.50	6,000
5.	Signage	3 EA	130.00	390
6.	Fencing & Concrete Curb	2,000 L.F.	22.00	44,000
7.	Bridges	-----	-----	-----
				<hr/>
			TOTAL:	\$55,190

COST ESTIMATE

HIKING AND RIDING TRAILS COMMUNITY TRAILS

Wilson Trail

Hellman Avenue - Archibald Avenue (3,000 l.f)

<u>Item</u>	<u>Quantity</u>	<u>Unit Price</u>	<u>Total</u>
1. Land Acquisition	-----	-----	-----
2. Demolition	-----	-----	-----
3. Grading	36,000 S.F.	.40	14,400
4. Decomposed Granite Surface	36,000 S.F.	.50	18,000
5. Signage	6 EA	130.00	780
6. Fencing & Concrete Curb	6,000 L.F.	22.00	132,000
7. Bridges	-----	-----	-----
			<hr/>
		TOTAL:	\$165,180

COST ESTIMATE

HIKING AND RIDING TRAILS COMMUNITY TRAILS

Wilson Trail

Archibald Avenue - Hermosa Avenue (2,500 l.f.)

<u>Item</u>	<u>Quantity</u>	<u>Unit Price</u>	<u>Total</u>
1. Land Acquisition	-----	-----	-----
2. Demolition	-----	-----	-----
3. Grading	30,000 S.F.	.40	12,000
4. Decomposed Granite Surface	30,000 S.F.	.50	15,000
5. Signage	5 EA	130.00	650
6. Fencing & Concrete Curb	2,500 L.F.	22.00	55,000
7. Bridges	-----	-----	-----
			<hr/>
		TOTAL:	\$82,650

COST ESTIMATE

HIKING AND RIDING TRAILS COMMUNITY TRAILS

Wilson Trail

Hermosa Avenue - Haven Avenue (3,000 l.f.)

A. New Construction

<u>Item</u>	<u>Quantity</u>	<u>Unit Price</u>	<u>Total</u>
1. Land Acquisition	-----	-----	-----
2. Demolition	-----	-----	-----
3. Grading	36,000 S.F.	.40	14,400
4. Decomposed Granite Surface	36,000 S.F.	.50	18,000
5. Signage	6 EA	130.00	780
6. Fencing & Concrete Curb	6,000 L.F.	22.00	132,000
7. Bridges	-----	-----	-----
Sub-Total:			\$165,180

B. Demolition & Reconstruction

<u>Item</u>	<u>Quantity</u>	<u>Unit Price</u>	<u>Total</u>
1. Landscape Demolition	960 S.F.	.30	288
2. Concrete Demolition	N/A	1.00	-----
3. Wall Demolition	N/A	20.00	-----
4. Tree Removal	3 EA	300.00	900
5. New 3' High Retaining Wall	80 L.F.	40.00	3,200
			\$4,388
20% Contingency			\$878
Sub-Total:			\$5,266
Budgeted Amount			\$5,500
TOTAL:			\$170,680

COST ESTIMATE

HIKING AND RIDING TRAILS COMMUNITY TRAILS

Wilson Trail

Haven Avenue - Deer Creek (4,600 l.f.)

A. New Construction

	<u>Item</u>	<u>Quantity</u>	<u>Unit Price</u>	<u>Total</u>
1.	Land Acquisition	-----	-----	-----
2.	Demolition	-----	-----	-----
3.	Grading	55,200 S.F.	.40	22,080
4.	Decomposed Granite Surface	55,200 S.F.	.50	27,600
5.	Signage	8 EA	130.00	1,040
6.	Fencing & Concrete Curb	7,590 L.F.	22.00	167,000
7.	Bridges	1 EA	25,000.00	25,000

Sub-Total: \$242,720

B. Demolition & Reconstruction

	<u>Item</u>	<u>Quantity</u>	<u>Unit Price</u>	<u>Total</u>
1.	Landscape Demolition	48,800 S.F.	.30	14,640
2.	Concrete Demolition	6,400 S.F.	1.00	6,400
3.	Wall Demolition	N/A	20.00	-----
4.	Tree Removal	N/A	300.00	-----
5.	New 3' High Retaining Wall	N/A	40.00	-----

\$21,040

20% Contingency \$4,208

Sub-Total: \$25,248

Budgeted Amount \$25,500

TOTAL: \$268,220

COST ESTIMATE

HIKING AND RIDING TRAILS COMMUNITY TRAILS

Wilson Trail

Deer Creek - Milliken Avenue (600 l.f.)

	<u>Item</u>	<u>Quantity</u>	<u>Unit Price</u>	<u>Total</u>
1.	Land Acquisition	-----	-----	-----
2.	Demolition	-----	-----	-----
3.	Grading	7,200 S.F.	.40	2,880
4.	Decomposed Granite Surface	7,200 S.F.	.50	3,600
5.	Signage	2 EA	130.00	260
6.	Fencing & Concrete Curb	1,227 L.F.	22.00	27,000
7.	Bridges	1 EA	25,000.00	25,000
				<hr/>
			TOTAL:	\$58,740

COST ESTIMATE

HIKING AND RIDING TRAILS COMMUNITY TRAILS

Wilson Trail

Milliken Avenue - Rochester Avenue (4,000 l.f.)

	<u>Item</u>	<u>Quantity</u>	<u>Unit Price</u>	<u>Total</u>
1.	Land Acquisition	-----	-----	-----
2.	Demolition	-----	-----	-----
3.	Grading	48,000 S.F.	.40	19,200
4.	Decomposed Granite Surface	48,000 S.F.	.50	24,000
5.	Signage	7 EA	130.00	910
6.	Fencing & Concrete Curb	8,000 L.F.	22.00	176,000
7.	Bridges	-----	-----	-----
				<hr/>
			TOTAL:	\$220,110

COST ESTIMATE

HIKING AND RIDING TRAILS COMMUNITY TRAILS

Wilson Trail

Rochester Avenue - Etiwanda Avenue (6,000 l.f.)

	<u>Item</u>	<u>Quantity</u>	<u>Unit Price</u>	<u>Total</u>
1.	Land Acquisition	-----	-----	-----
2.	Demolition	-----	-----	-----
3.	Grading	72,000 S.F.	.40	28,800
4.	Decomposed Granite Surface	72,000 S.F.	.50	36,000
5.	Signage	10 EA	130.00	1,300
6.	Fencing & Concrete Curb	12,000 L.F.	22.00	264,000
7.	Bridges	-----	-----	-----
				<hr/>
			TOTAL:	\$330,100

COST ESTIMATE

HIKING AND RIDING TRAILS COMMUNITY TRAILS

Wilson Trail

Etiwanda Avenue - East Avenue (3,000 l.f.)

	<u>Item</u>	<u>Quantity</u>	<u>Unit Price</u>	<u>Total</u>
1.	Land Acquisition	-----	-----	-----
2.	Demolition	-----	-----	-----
3.	Grading	36,000 S.F.	.40	14,400
4.	Decomposed Granite Surface	36,000 S.F.	.50	18,000
5.	Signage	6 EA	130.00	780
6.	Fencing & Concrete Curb	6,000 L.F.	22.00	132,000
7.	Bridges	-----	-----	-----
				<hr/>
			TOTAL:	\$165,180

COST ESTIMATE

HIKING AND RIDING TRAILS COMMUNITY TRAILS

Wilson Trail

East Avenue - E. City Limit (8,500 l.f.)

<u>Item</u>	<u>Quantity</u>	<u>Unit Price</u>	<u>Total</u>
1. Land Acquisition	-----	-----	-----
2. Demolition	-----	-----	-----
3. Grading	102,000 S.F.	.40	40,800
4. Decomposed Granite Surface	102,000 S.F.	.50	51,000
5. Signage	14 EA	130.00	1,820
6. Fencing & Concrete Curb	17,000 L.F.	22.00	374,000
7. Bridges	-----	-----	-----
			<hr/>
		TOTAL:	\$467,620

COST ESTIMATE

HIKING AND RIDING TRAILS COMMUNITY TRAILS

Banyan Street

Cucamonga Creek - Sapphire Street (1,000 l.f.)

	<u>Item</u>	<u>Quantity</u>	<u>Unit Price</u>	<u>Total</u>
1.	Land Acquisition	-----	-----	-----
2.	Demolition	-----	-----	-----
3.	Grading	12,000 S.F.	.40	4,800
4.	Decomposed Granite Surface	12,000 S.F.	.50	6,000
5.	Signage	3 EA	130.00	390
6.	Fencing & Concrete Curb	1,000 L.F.	22.00	22,000
7.	Bridges	-----	-----	-----
				<hr/>
			Total:	\$33,190

COST ESTIMATE

HIKING AND RIDING TRAILS COMMUNITY TRAILS

Banyan Street

Sapphire Street - Carnelian Street (2,500 l.f.)

A. New Construction

	<u>Item</u>	<u>Quantity</u>	<u>Unit Price</u>	<u>Total</u>
1.	Land Acquisition	.14 ACRE	100,000.00	14,000
2.	Demolition	-----	-----	-----
3.	Grading	30,000 S.F.	.40	12,000
4.	Decomposed Granite Surface	30,000 S.F.	.50	15,000
5.	Signage	5 EA	130.00	650
6.	Fencing & Concrete Curb	5,000 L.F.	22.00	110,000
7.	Bridges	-----	-----	-----
Sub-Total:				\$151,650

B. Demolition & Reconstruction

	<u>Item</u>	<u>Quantity</u>	<u>Unit Price</u>	<u>Total</u>
1.	Landscape Demolition	17,280 S.F.	.30	5,184
2.	Concrete Demolition	N/A	1.00	-----
3.	Wall Demolition	N/A	20.00	-----
4.	Tree Removal	25 EA	300.00	7,500
5.	New 3' High Retaining Wall	N/A	40.00	-----
				\$12,684
20% Contingency				\$2,537
Sub-Total:				\$15,221
Budgeted Amount				\$15,000
TOTAL:				\$166,650

COST ESTIMATE

HIKING AND RIDING TRAILS COMMUNITY TRAILS

Banyan Street

Carnelian Street - Hellman Avenue (4,000 l.f.)

A. New Construction

<u>Item</u>	<u>Quantity</u>	<u>Unit Price</u>	<u>Total</u>
1. Land Acquisition	.06 ACRE	100,000.00	6,000
2. Demolition	-----	-----	-----
3. Grading	48,000 S.F.	.40	19,200
4. Decomposed Granite Surface	48,000 S.F.	.50	24,000
5. Signage	7 EA	130.00	910
6. Fencing & Concrete Curb	8,000 L.F.	22.00	176,000
7. Bridges	-----	-----	-----
Sub-Total:			\$226,110

B. Demolition & Reconstruction

<u>Item</u>	<u>Quantity</u>	<u>Unit Price</u>	<u>Total</u>
1. Landscape Demolition	1,440 S.F.	.30	432
2. Concrete Demolition	N/A	1.00	-----
3. Wall Demolition	N/A	20.00	-----
4. Tree Removal	18 EA	300.00	5,400
5. New 3' High Retaining Wall	N/A	40.00	-----
Sub-Total:			\$5,832
20% Contingency			\$1,166
Sub-Total:			\$6,998
Budgeted Amount			\$7,000
TOTAL:			\$233,110

COST ESTIMATE

HIKING AND RIDING TRAILS COMMUNITY TRAILS

Banyan Street

Hellman Avenue - Archibald Avenue (2,500 l.f.)

A. New Construction

<u>Item</u>	<u>Quantity</u>	<u>Unit Price</u>	<u>Total</u>
1. Land Acquisition	.11 ACRE	100,000.00	11,000
2. Demolition	-----	-----	-----
3. Grading	30,000 S.F.	.40	12,000
4. Decomposed Granite Surface	30,000 S.F.	.50	15,000
5. Signage	5 EA	130.00	650
6. Fencing & Concrete Curb	5,000 L.F.	22.00	110,000
7. Bridges	-----	-----	-----
Sub-Total:			\$148,650

B. Demolition & Reconstruction

<u>Item</u>	<u>Quantity</u>	<u>Unit Price</u>	<u>Total</u>
1. Landscape Demolition	13,440 S.F.	.30	4,032
2. Concrete Demolition	N/A	1.00	-----
3. Wall Demolition	N/A	20.00	-----
4. Tree Removal	26 EA	300.00	7,800
5. New 3' High Retaining Wall	N/A	40.00	-----
Sub-Total:			\$11,832
20% Contingency			\$2,366
Sub-Total:			\$14,198
Budgeted Amount			\$14,000
TOTAL:			\$162,650

COST ESTIMATE

HIKING AND RIDING TRAILS COMMUNITY TRAILS

Banyan Street

Archibald Avenue - Hermosa Avenue (2,500 l.f.)

A. New Construction

<u>Item</u>	<u>Quantity</u>	<u>Unit Price</u>	<u>Total</u>
1. Land Acquisition	.04 ACRE	100,000.00	4,000
2. Demolition	-----	-----	-----
3. Grading	30,000 S.F.	.40	12,000
4. Decomposed Granite Surface	30,000 S.F.	.50	15,000
5. Signage	5 EA	130.00	650
6. Fencing & Concrete Curb	5,000 L.F.	22.00	110,000
7. Bridges	-----	-----	-----
Sub-Total:			\$141,650

B. Demolition & Reconstruction

<u>Item</u>	<u>Quantity</u>	<u>Unit Price</u>	<u>Total</u>
1. Landscape Demolition	3,840 S.F.	.30	1,152
2. Concrete Demolition	N/A	1.00	-----
3. Wall Demolition	N/A	20.00	-----
4. Tree Removal	5 EA	300.00	1,500
5. New 3' High Retaining Wall	N/A	40.00	-----
			\$2,652
20% Contingency			\$530
Sub-Total:			\$3,182
Budgeted Amount			\$3,000
TOTAL:			\$144,650

COST ESTIMATE

HIKING AND RIDING TRAILS COMMUNITY TRAILS

Banyan Street

Hermosa Avenue - Haven Avenue (2,500 l.f.)

	<u>Item</u>	<u>Quantity</u>	<u>Unit Price</u>	<u>Total</u>
1.	Land Acquisition	1.15 ACRE	100,000.00	115,000
2.	Demolition	-----	-----	-----
3.	Grading	30,000 S.F.	.40	12,000
4.	Decomposed Granite Surface	30,000 S.F.	.50	15,000
5.	Signage	5 EA	130.00	650
6.	Fencing & Concrete Curb	5,000 L.F.	22.00	110,000
7.	Bridges	-----	-----	-----
TOTAL:				<hr/> \$252,650

COST ESTIMATE

HIKING AND RIDING TRAILS COMMUNITY TRAILS

Banyan Street

Haven Avenue - Milliken Avenue (5,000 l.f.)

	<u>Item</u>	<u>Quantity</u>	<u>Unit Price</u>	<u>Total</u>
1.	Land Acquisition	-----	-----	-----
2.	Demolition	-----	-----	-----
3.	Grading	60,000 S.F.	.40	24,000
4.	Decomposed Granite Surface	60,000 S.F.	.50	30,000
5.	Signage	9 EA	130.00	1,170
6.	Fencing & Concrete Curb	8,318 L.F.	22.00	183,000
7.	Bridges	1 EA	25,000.00	25,000
				<hr/>
			TOTAL:	\$263,170

COST ESTIMATE

HIKING AND RIDING TRAILS COMMUNITY TRAILS

Banyan Street

Milliken Avenue - Rochester Avenue (4,000 l.f.)

<u>Item</u>	<u>Quantity</u>	<u>Unit Price</u>	<u>Total</u>
1. Land Acquisition	-----	-----	-----
2. Demolition	-----	-----	-----
3. Grading	48,000 S.F.	.40	19,200
4. Decomposed Granite Surface	48,000 S.F.	.50	24,000
5. Signage	7 EA	130.00	910
6. Fencing & Concrete Curb	8,000 L.F.	22.00	176,000
7. Bridges	-----	-----	-----
			<hr/>
		TOTAL:	\$220,110

COST ESTIMATE

HIKING AND RIDING TRAILS COMMUNITY TRAILS

Banyan Street

Rochester Avenue - W. of Etiwanda Avenue (6,000 l.f.)

	<u>Item</u>	<u>Quantity</u>	<u>Unit Price</u>	<u>Total</u>
1.	Land Acquisition	-----	-----	-----
2.	Demolition	-----	-----	-----
3.	Grading	72,000 S.F.	.40	28,800
4.	Decomposed Granite Surface	72,000 S.F.	.50	36,000
5.	Signage	10 EA	130.00	1,300
6.	Fencing & Concrete Curb	12,000 L.F.	22.00	264,000
7.	Bridges	1 EA	25,000.00	25,000
				<hr/>
			TOTAL:	\$355,100

COST ESTIMATE

HIKING AND RIDING TRAILS COMMUNITY TRAILS

Lower Summit Avenue

W. of Etiwanda Avenue - East Avenue (2,500 l.f.)

<u>Item</u>	<u>Quantity</u>	<u>Unit Price</u>	<u>Total</u>
1. Land Acquisition	-----	-----	-----
2. Demolition	-----	-----	-----
3. Grading	30,000 S.F.	.40	12,000
4. Decomposed Granite Surface	30,000 S.F.	.50	15,000
5. Signage	5 EA	130.00	650
6. Fencing & Concrete Curb	5,000 L.F.	22.00	110,000
7. Bridges	-----	-----	-----
			<hr/>
		TOTAL:	\$137,650

COST ESTIMATE

HIKING AND RIDING TRAILS COMMUNITY TRAILS

Lower Summit Avenue
East Avenue - Loop (5,000 l.f.)

<u>Item</u>	<u>Quantity</u>	<u>Unit Price</u>	<u>Total</u>
1. Land Acquisition	-----	-----	-----
2. Demolition	-----	-----	-----
3. Grading	60,000 S.F.	.40	24,000
4. Decomposed Granite Surface	60,000 S.F.	.50	30,000
5. Signage	9 EA	130.00	1,170
6. Fencing & Concrete Curb	10,000 L.F.	22.00	220,000
7. Bridges	-----	-----	-----
			<hr/>
		TOTAL:	\$275,170

COST ESTIMATE

HIKING AND RIDING TRAILS COMMUNITY TRAILS

Blue Gum Trail

Etiwanda Avenue - East Avenue (2,000 l.f.)

	<u>Item</u>	<u>Quantity</u>	<u>Unit Price</u>	<u>Total</u>
1.	Land Acquisition	-----	-----	-----
2.	Demolition	-----	-----	-----
3.	Grading	24,000 S.F.	.40	9,600
4.	Decomposed Granite Surface	24,000 S.F.	.50	12,000
5.	Signage	4 EA	130.00	520
6.	Fencing & Concrete Curb	4,000 L.F.	22.00	88,000
7.	Bridges	-----	-----	-----
				<hr/>
TOTAL:				\$110,120

COST ESTIMATE

HIKING AND RIDING TRAILS COMMUNITY TRAILS

Blue Gum Trail

East Avenue - Loop (6,000 l.f.)

	<u>Item</u>	<u>Quantity</u>	<u>Unit Price</u>	<u>Total</u>
1.	Land Acquisition	-----	-----	-----
2.	Demolition	-----	-----	-----
3.	Grading	72,000 S.F.	.40	28,800
4.	Decomposed Granite Surface	72,000 S.F.	.50	36,000
5.	Signage	10 EA	130.00	1,300
6.	Fencing & Concrete Curb	7,454 L.F.	22.00	164,000
7.	Bridges	-----	-----	-----
				<hr/>
			TOTAL:	\$230,100

COST ESTIMATE

**HIKING AND RIDING TRAILS
COMMUNITY TRAILS**

COST ESTIMATE

**HIKING AND RIDING TRAILS
COMMUNITY TRAILS**

COST ESTIMATE
HIKING AND RIDING TRAILS
COMMUNITY TRAILS

COST ESTIMATE

HIKING AND RIDING TRAILS COMMUNITY TRAILS

Victoria Park Lane

Rochester Avenue - Day Creek Blvd. (2,000 l.f.)

	<u>Item</u>	<u>Quantity</u>	<u>Unit Price</u>	<u>Total</u>
1.	Land Acquisition	-----	-----	-----
2.	Demolition	-----	-----	-----
3.	Grading	24,000 S.F.	.40	9,600
4.	Decomposed Granite Surface	24,000 S.F.	.50	12,000
5.	Signage	4 EA	130.00	520
6.	Fencing & Concrete Curb	4,000 L.F.	22.00	88,000
7.	Bridges	-----	-----	-----
				<hr/>
			TOTAL:	\$110,120

COST ESTIMATE

HIKING AND RIDING TRAILS COMMUNITY TRAILS

Victoria Park Lane

Day Creek Blvd. - N. Victoria Windrows Loop (1,000 l.f.)

	<u>Item</u>	<u>Quantity</u>	<u>Unit Price</u>	<u>Total</u>
1.	Land Acquisition	-----	-----	-----
2.	Demolition	-----	-----	-----
3.	Grading	12,000 S.F.	.40	4,800
4.	Decomposed Granite Surface	12,000 S.F.	.50	6,000
5.	Signage	3 EA	130.00	390
6.	Fencing & Concrete Curb	2,000 L.F.	22.00	44,000
7.	Bridges	-----	-----	-----
				<hr/>
TOTAL:				\$55,190

COST ESTIMATE
HIKING AND RIDING TRAILS
COMMUNITY TRAILS

COST ESTIMATE

**HIKING AND RIDING TRAILS
COMMUNITY TRAILS**

COST ESTIMATE
HIKING AND RIDING TRAILS
COMMUNITY TRAILS

COST ESTIMATE

HIKING AND RIDING TRAILS COMMUNITY TRAILS

N. Victoria Windrows Loop

Victoria Park Lane - E. of Tipu Place (1,000 l.f.)

<u>Item</u>	<u>Quantity</u>	<u>Unit Price</u>	<u>Total</u>
1. Land Acquisition	-----	-----	-----
2. Demolition	-----	-----	-----
3. Grading	12,000 S.F.	.40	4,800
4. Decomposed Granite Surface	12,000 S.F.	.50	6,000
5. Signage	3 EA	130.00	390
6. Fencing & Concrete Curb	2,000 L.F.	22.00	44,000
7. Bridges	-----	-----	-----
			<hr/>
		TOTAL:	\$55,190

COST ESTIMATE

**HIKING AND RIDING TRAILS
COMMUNITY TRAILS**

COST ESTIMATE

**HIKING AND RIDING TRAILS
COMMUNITY TRAILS**

COST ESTIMATE
HIKING AND RIDING TRAILS
COMMUNITY TRAILS

COST ESTIMATE
HIKING AND RIDING TRAILS
COMMUNITY TRAILS

COST ESTIMATE

HIKING AND RIDING TRAILS COMMUNITY TRAILS

Church Street

Rochester Avenue - Day Creek Channel (1,500 l.f.)

<u>Item</u>	<u>Quantity</u>	<u>Unit Price</u>	<u>Total</u>
1. Land Acquisition	-----	-----	-----
2. Demolition	-----	-----	-----
3. Grading	18,000 S.F.	.40	7,200
4. Decomposed Granite Surface	18,000 S.F.	.50	9,000
5. Signage	3 EA	130.00	390
6. Fencing & Concrete Curb	3,000 L.F.	22.00	66,000
7. Bridges	-----	-----	-----
			<hr/>
		TOTAL:	\$82,590

COST ESTIMATE

HIKING AND RIDING TRAILS COMMUNITY TRAILS

Miller Avenue

Day Creek Channel - Day Creek Blvd. (1,000 l.f.)

<u>Item</u>	<u>Quantity</u>	<u>Unit Price</u>	<u>Total</u>
1. Land Acquisition	-----	-----	-----
2. Demolition	-----	-----	-----
3. Grading	12,000 S.F.	.40	4,800
4. Decomposed Granite Surface	12,000 S.F.	.50	6,000
5. Signage	3 EA	130.00	390
6. Fencing & Concrete Curb	2,000 L.F.	22.00	44,000
7. Bridges	-----	-----	-----
			<hr/>
		TOTAL:	\$55,190

COST ESTIMATE

HIKING AND RIDING TRAILS COMMUNITY TRAILS

Miller Avenue

Day Creek Blvd. - Victoria Park Place (mid-block) (1,500 l.f.)

	<u>Item</u>	<u>Quantity</u>	<u>Unit Price</u>	<u>Total</u>
1.	Land Acquisition	-----	-----	-----
2.	Demolition	-----	-----	-----
3.	Grading	18,000 S.F.	.40	7,200
4.	Decomposed Granite Surface	18,000 S.F.	.50	9,000
5.	Signage	3 EA	130.00	390
6.	Fencing & Concrete Curb	3,000 L.F.	22.00	66,000
7.	Bridges	-----	-----	-----
				<hr/>
			TOTAL:	\$82,590

COST ESTIMATE

HIKING AND RIDING TRAILS COMMUNITY TRAILS

Southern Pacific Railroad

W. City Limit - Grove Avenue (1,500 l.f.)

<u>Item</u>	<u>Quantity</u>	<u>Unit Price</u>	<u>Total</u>
1. Land Acquisition	-----	-----	-----
2. Demolition	-----	-----	-----
3. Grading	18,000 S.F.	.40	7,200
4. Decomposed Granite Surface	18,000 S.F.	.50	9,000
5. Signage	3 EA	130.00	390
6. Fencing & Concrete Curb	3000 L.F.	22.00	66,000
7. Bridges	-----	-----	-----
			<hr/>
		TOTAL:	\$82,590

COST ESTIMATE

HIKING AND RIDING TRAILS COMMUNITY TRAILS

Southern Pacific Railroad
Grove Avenue - Base Line (11,000 l.f.)

<u>Item</u>	<u>Quantity</u>	<u>Unit Price</u>	<u>Total</u>
1. Land Acquisition	-----	-----	-----
2. Demolition	-----	-----	-----
3. Grading	132,000 S.F.	.40	52,800
4. Decomposed Granite Surface	132,000 S.F.	.50	66,000
5. Signage	18 EA	130.00	2,340
6. Fencing & Concrete Curb	22,000 L.F.	22.00	484,000
7. Bridges	-----	-----	-----
			<hr/>
		TOTAL:	\$605,140

COST ESTIMATE

HIKING AND RIDING TRAILS COMMUNITY TRAILS

Southern Pacific Railroad

Base Line - Archibald Avenue (2,500 l.f.)

<u>Item</u>	<u>Quantity</u>	<u>Unit Price</u>	<u>Total</u>
1. Land Acquisition	-----	-----	-----
2. Demolition	-----	-----	-----
3. Grading	30,000 S.F.	.40	12,000
4. Decomposed Granite Surface	30,000 S.F.	.50	15,000
5. Signage	5 EA	130.00	650
6. Fencing & Concrete Curb	5,000 L.F.	22.00	110,000
7. Bridges	-----	-----	-----
			<hr/>
		TOTAL:	\$137,650

COST ESTIMATE

HIKING AND RIDING TRAILS COMMUNITY TRAILS

Southern Pacific Railroad

Archibald Avenue - Haven Avenue (5,000 l.f.)

	<u>Item</u>	<u>Quantity</u>	<u>Unit Price</u>	<u>Total</u>
1.	Land Acquisition	-----	-----	-----
2.	Demolition	-----	-----	-----
3.	Grading	60,000 S.F.	.40	24,000
4.	Decomposed Granite Surface	60,000 S.F.	.50	30,000
5.	Signage	9 EA	130.00	1,170
6.	Fencing & Concrete Curb	10,000 L.F.	22.00	220,000
7.	Bridges	-----	-----	-----
				<hr/>
			TOTAL:	\$275,170

COST ESTIMATE

HIKING AND RIDING TRAILS COMMUNITY TRAILS

Southern Pacific Railroad

Haven Avenue - Milliken Avenue (5,000 l.f.)

	<u>Item</u>	<u>Quantity</u>	<u>Unit Price</u>	<u>Total</u>
1.	Land Acquisition	-----	-----	-----
2.	Demolition	-----	-----	-----
3.	Grading	60,000 S.F.	.40	24,000
4.	Decomposed Granite Surface	60,000 S.F.	.50	30,000
5.	Signage	9 EA	130.00	1,170
6.	Fencing & Concrete Curb	10,000 L.F.	22.00	220,000
7.	Bridges	-----	-----	-----
				<hr/>
			TOTAL:	\$275,170

COST ESTIMATE

HIKING AND RIDING TRAILS COMMUNITY TRAILS

Southern Pacific Railroad

Milliken Avenue - Rochester Avenue (4,000 l.f.)

<u>Item</u>	<u>Quantity</u>	<u>Unit Price</u>	<u>Total</u>
1. Land Acquisition	-----	-----	-----
2. Demolition	-----	-----	-----
3. Grading	48,000 S.F.	.40	19,200
4. Decomposed Granite Surface	48,000 S.F.	.50	24,000
5. Signage	7 EA	130.00	910
6. Fencing & Concrete Curb	8,000 L.F.	22.00	176,000
7. Bridges	-----	-----	-----
			<hr/>
		TOTAL:	\$220,110

COST ESTIMATE

HIKING AND RIDING TRAILS COMMUNITY TRAILS

Southern Pacific Railroad

Rochester Avenue - Etiwanda Avenue (6,500 l.f.)

<u>Item</u>	<u>Quantity</u>	<u>Unit Price</u>	<u>Total</u>
1. Land Acquisition	-----	-----	-----
2. Demolition	-----	-----	-----
3. Grading	78,000 S.F.	.40	31,200
4. Decomposed Granite Surface	78,000 S.F.	.50	39,000
5. Signage	11 EA	130.00	1,430
6. Fencing & Concrete Curb	13,000 L.F.	22.00	286,000
7. Bridges	-----	-----	-----
			<hr/>
		TOTAL:	\$357,630

COST ESTIMATE

HIKING AND RIDING TRAILS COMMUNITY TRAILS

Southern Pacific Railroad

Etiwanda Avenue - E. City Limit (3,500 l.f.)

<u>Item</u>	<u>Quantity</u>	<u>Unit Price</u>	<u>Total</u>
1. Land Acquisition	-----	-----	-----
2. Demolition	-----	-----	-----
3. Grading	42,000 S.F.	.40	16,800
4. Decomposed Granite Surface	42,000 S.F.	.50	21,000
5. Signage	6 EA	130.00	780
6. Fencing & Concrete Curb	7,000 L.F.	22.00	154,000
7. Bridges	-----	-----	-----
			<hr/>
		TOTAL:	\$192,580

BIKEWAY COST ESTIMATES -- CLASS I

LAST REVISED: 28-Oct-91

CLASSIFICATION/LOCATION	TOTAL COST	CONSTRUCTION COSTS								TOTAL CONST. COST	OTHER COSTS (% TOTAL CONST. COST)			TOTAL OTHER COST
		LAND ACQ.	PAVEMENT	PAVEMENT MARKINGS	PAVEMENT LANE LINES	SIGNAGE	LIGHTING	UNDER-CROSSINGS AT ROADS	SIGNAL CROSSINGS		ADMIN. (22%)	DESIGN (12%)	INSP. (8%)	
CUCAMONGA CREEK														
N. City Limits - 19th Street	242,190	0	0	216	0	2,340	168,000	0	0	170,556	37,522	20,467	13,644	71,634
19th Street - Base Line	103,853	0	0	96	0	1,040	72,000	0	0	73,136	16,090	8,776	5,851	30,717
Base Line - Foothill Blvd.	3,533,355	0	0	108	0	1,170	87,000	2,400,000	0	2,488,278	547,421	298,593	199,062	1,045,077
Foothill Blvd. - Arrow Route	60,648	0	0	60	0	650	42,000	0	0	42,710	9,396	5,125	3,417	17,938
Arrow Route - 4th Street	21,905	0	0	36	0	390	15,000	0	0	15,426	3,394	1,851	1,234	6,479
TOTAL -- CUCAMONGA CREEK	3,961,951	0	0	516	0	5,590	384,000	2,400,000	0	2,790,106	613,823	334,813	223,208	1,171,845
DEMENS CHANNEL														
N. City Limits - Cucamonga Creek	3,606,985	0	0	180	0	1,950	138,000	2,400,000	0	2,540,130	558,829	304,816	203,210	1,066,855
TOTAL -- DEMENS CHANNEL	3,606,985	0	0	180	0	1,950	138,000	2,400,000	0	2,540,130	558,829	304,816	203,210	1,066,855
DEER CREEK														
N. City Limits - Main Creek Inter.	155,780	0	0	144	0	1,560	108,000	0	0	109,704	24,135	13,164	8,776	46,076
Main Creek Inter. - Highland Ave.	3,576,560	0	0	144	0	1,560	117,000	2,400,000	0	2,518,704	554,115	302,244	201,496	1,057,856
Highland Avenue - Base Line	5,237,355	0	0	108	0	1,170	87,000	3,600,000	0	3,688,278	811,421	442,593	295,062	1,549,077
Base Line - Foothill Blvd.	1,829,355	0	0	108	0	1,170	87,000	1,200,000	0	1,288,278	283,421	154,593	103,062	541,077
Foothill Blvd. - Arrow Route	60,648	0	0	60	0	650	42,000	0	0	42,710	9,396	5,125	3,417	17,938
Arrow Route - 4th Street	168,560	0	0	144	0	1,560	117,000	0	0	118,704	26,115	14,244	9,496	49,856
TOTAL -- DEER CREEK	11,028,257	0	0	708	0	7,670	558,000	7,200,000	0	7,766,378	1,708,603	931,965	621,310	3,261,879
DAY CREEK														
N. City Limit (Wilson) - Highland	3,520,575	0	0	108	0	1,170	78,000	2,400,000	0	2,479,278	545,441	297,513	198,342	1,041,297
Highland Avenue - Base Line	5,309,775	0	60,000	108	0	1,170	78,000	3,600,000	0	3,739,278	822,641	448,713	299,142	1,570,497
Base Line - Foothill Blvd.	3,520,575	0	0	108	0	1,170	78,000	2,400,000	0	2,479,278	545,441	297,513	198,342	1,041,297
Foothill Blvd. - Arrow Route	111,970	0	0	72	0	780	48,000	0	30,000	78,852	17,347	9,462	6,308	33,118
Arrow Route - 4th Street	3,647,560	0	0	144	0	1,560	117,000	2,400,000	50,000	2,568,704	565,115	308,244	205,496	1,078,856
TOTAL -- DAY CREEK	16,110,454	0	60,000	540	0	5,850	399,000	10,800,000	80,000	11,345,390	2,495,986	1,361,447	907,631	4,765,064
ETIWANDA AVENUE														
24th Street - Highland Ave.	197,775	0	60,000	108	0	1,170	78,000	0	0	139,278	30,641	16,713	11,142	58,497
Highland Ave. - Base Line	219,075	0	66,000	108	0	1,170	87,000	0	0	154,278	33,941	18,513	12,342	64,797
TOTAL -- ETIWANDA AVENUE	416,850	0	126,000	216	0	2,340	165,000	0	0	293,556	64,582	35,227	23,484	123,294

BIKEWAY COST ESTIMATES -- CLASS I

LAST REVISED: 04-Nov-91

CLASSIFICATION/LOCATION	TOTAL COST	CONSTRUCTION COSTS								TOTAL CONST. COST	OTHER COSTS (% TOTAL CONST. COST)			TOTAL OTHER COST
		LAND ACQ.	PAVEMENT	PAVEMENT MARKINGS	PAVEMENT LANE	PAVEMENT LINEN	SIGNAGE	LIGHTING	UNDER-CROSSINGS AT ROADS		SIGNAL CROSSINGS	ADMIN. (22%)	DESIGN (12%)	
BIKEWAY COST ESTIMATES -- CLASS I														
LAST REVISED: 04-Nov-91														
24TH STREET														
City Limit (W) - Etiwanda Avenue	120,490	0	36,000	72	0	780	48,000	0	0	84,852	18,667	10,182	6,788	35,638
Etiwanda Avenue - East Avenue	103,248	0	30,000	60	0	650	42,000	0	0	72,710	15,996	8,725	5,817	30,538
East Avenue - Wardman Bullock Road	120,490	0	36,000	72	0	780	48,000	0	0	84,852	18,667	10,182	6,788	35,638
Wardman Bullock Road - Cherry Ave.	219,075	0	66,000	108	0	1,170	87,000	0	0	154,278	33,941	18,513	12,342	64,797
TOTAL -- 24TH STREET	563,303	0	168,000	312	0	3,380	225,000	0	0	396,692	87,272	47,603	31,735	166,611
SOUTHERN PACIFIC RAILROAD														
W. City Limit - Grove Avenue	145,243	0	6,000	24	0	260	12,000	0	84,000	102,284	22,502	12,274	8,183	42,959
Grove Avenue - Base Line	497,790	0	132,000	216	0	2,340	168,000	0	48,000	350,556	77,122	42,067	28,044	147,234
Base Line - Archibald Ave.	154,570	0	36,000	72	0	780	48,000	0	24,000	108,852	23,947	13,062	8,708	45,718
Archibald Ave. - Haven Ave.	282,975	0	60,000	108	0	1,170	78,000	0	60,000	199,278	43,841	23,913	15,942	83,697
Haven Ave. - Milliken Ave.	214,815	0	60,000	108	0	1,170	78,000	0	12,000	151,278	33,281	18,153	12,102	63,537
Milliken Ave. - Rochester Ave.	193,111	0	48,000	84	0	910	63,000	0	24,000	135,994	29,919	16,319	10,880	57,117
Rochester Ave. - Etiwanda Ave.	307,376	0	78,000	132	0	330	102,000	0	36,000	216,462	47,622	25,975	17,317	90,914
Etiwanda Avenue - E. City Limit	158,830	0	42,000	72	0	780	57,000	0	12,000	111,852	24,607	13,422	8,948	46,978
TOTAL -- SOUTHERN PACIFIC RAILROAD	1,954,710	0	462,000	816	0	7,740	606,000	0	300,000	1,376,556	302,842	165,187	110,124	578,154
TERRA VISTA GREENWAY														
Milliken Ave. - Rochester Ave.	200,010	0	80,000	72	0	780	60,000	0	0	140,852	30,987	16,902	11,268	59,158
TOTAL -- TERRA VISTA GREENWAY	200,010	0	80,000	72	0	780	60,000	0	0	140,852	30,987	16,902	11,268	59,158
GRAND TOTAL	37,842,517	0	896,000	3,144	0	35,300	2,535,000	22,800,000	380,000	26,649,660	5,831,938	3,181,057	2,120,705	11,133,699

BIKEWAY COST ESTIMATES -- CLASS II

LAST REVISED: 28-JUN-1991

CLASSIFICATION/LOCATION	TOTAL COST	CONSTRUCTION COSTS								TOTAL CONST. COST	OTHER COSTS (% TOTAL CONST. COST)			TOTAL OTHER COST
		LAND ACQ.	PAVEMENT PAVEMENT	PAVEMENT MARKINGS	PAVEMENT LANE LINES	SIGNAGE	LIGHTING	UNDER-CROSSINGS AT ROADS	SIGNAL CROSSINGS		ADMIN. (22%)	DESIGN (12%)	INSP. (8%)	
ETIWANDA AVENUE														
Base Line - Foothill Blvd.	6,492	0	0	192	2,300	2,080	0	0	0	4,572	1,006	549	366	1,920
Foothill Blvd. - Arrow Route	3,448	0	0	108	1,150	1,170	0	0	0	2,428	534	291	194	1,020
Arrow Route - 4th St.	9,738	0	0	288	3,450	3,120	0	0	0	6,858	1,509	823	549	2,880
TOTAL -- ETIWANDA AVENUE	19,678	0	0	588	6,900	6,370	0	0	0	13,858	3,049	1,663	1,109	5,820
EAST AVENUE														
24th St. - Highland Ave.	7,222	0	0	216	2,530	2,340	0	0	0	5,086	1,119	610	407	2,136
Highland Ave. - Base Line	6,492	0	0	192	2,300	2,080	0	0	0	4,572	1,006	549	366	1,920
TOTAL -- EAST AVENUE	13,714	0	0	408	4,830	4,420	0	0	0	9,658	2,125	1,159	773	4,056
24TH STREET														
Cherry Ave. - E. City Limit	3,976	0	0	120	1,380	1,300	0	0	0	2,800	616	336	224	1,176
TOTAL -- 24TH STREET	3,976	0	0	120	1,380	1,300	0	0	0	2,800	616	336	224	1,176
19TH STREET														
W. City Limit - Carnelian St.	3,976	0	0	120	1,380	1,300	0	0	0	2,800	616	336	224	1,176
Carnelian St. - Archibald Ave.	8,480	0	0	252	2,990	2,730	0	0	0	5,972	1,314	717	478	2,508
Archibald Ave. - Haven Ave.	6,492	0	0	192	2,300	2,080	0	0	0	4,572	1,006	549	366	1,920
Haven Ave. - Highland Ave.	4,706	0	0	144	1,610	1,560	0	0	0	3,314	729	398	265	1,392
TOTAL -- 19TH STREET	23,654	0	0	708	8,280	7,670	0	0	0	16,658	3,665	1,999	1,333	6,996
VICTORIA PARK LANE														
Milliken Ave. - Rochester Ave.	6,492	0	0	192	2,300	2,080	0	0	0	4,572	1,006	549	366	1,920
Rochester - E. of future Day Creek	2,718	0	0	84	920	910	0	0	0	1,914	421	230	153	804
E. of future Day Creek - Base Line	5,234	0	0	156	1,840	1,690	0	0	0	3,686	811	442	295	1,548
Base Line - Miller Ave.	3,976	0	0	120	1,380	1,300	0	0	0	2,800	616	336	224	1,176
TOTAL -- VICTORIA PARK LANE	18,420	0	0	552	6,440	5,980	0	0	0	12,972	2,854	1,557	1,038	5,448

BIKEWAY COST ESTIMATES -- CLASS II

LAST REVISED: 28-JUN-1991

CLASSIFICATION/LOCATION	CONSTRUCTION COSTS									OTHER COSTS (% TOTAL CONST. COST)				TOTAL OTHER COST
	TOTAL COST	LAND ACQ.	PAVEMENT MARKINGS	PAVEMENT LANE LINES	SIGNAGE	LIGHTING	UNDER- CROSSINGS AT ROADS	SIGNAL CROSSINGS	TOTAL CONST. COST	ADMIN. (22%)	DESIGN (12%)	INSP. (8%)		
BASE LINE														
W. City Limit - Carnelian St.	3,448	0	0	108	1,150	1,170	0	0	0	2,428	534	291	194	1,020
Carnelian St. - Archibald Ave.	8,480	0	0	252	2,990	2,730	0	0	0	5,972	1,314	717	478	2,508
Archibald Ave. - Haven Ave.	6,492	0	0	192	2,300	2,080	0	0	0	4,572	1,006	549	366	1,920
Haven Ave. - Milliken Ave.	6,492	0	0	192	2,300	2,080	0	0	0	4,572	1,006	549	366	1,920
Milliken Ave. - Rochester Ave.	5,234	0	0	156	1,840	1,690	0	0	0	3,686	811	442	295	1,548
Rochester Ave. - Etiwanda Ave.	8,480	0	0	252	2,990	2,730	0	0	0	5,972	1,314	717	478	2,508
Etiwanda Ave. - E. City Limit	3,448	0	0	108	1,150	1,170	0	0	0	2,428	534	291	194	1,020
TOTAL -- BASE LINE	42,075	0	0	1,260	14,720	13,650	0	0	0	29,630	6,519	3,556	2,370	12,445
MILLER AVENUE														
Rochester Ave. - Etiwanda Ave.	9,738	0	0	288	3,450	3,120	0	0	0	6,858	1,509	823	549	2,880
TOTAL -- MILLER AVENUE	9,738	0	0	288	3,450	3,120	0	0	0	6,858	1,509	823	549	2,880
ARROW ROUTE														
Baker Ave. - Archibald Ave.	9,738	0	0	288	3,450	3,120	0	0	0	6,858	1,509	823	549	2,880
Archibald Ave. - Haven Ave.	6,492	0	0	192	2,300	2,080	0	0	0	4,572	1,006	549	366	1,920
Haven Ave. - Milliken Ave.	7,222	0	0	216	2,530	2,340	0	0	0	5,086	1,119	610	407	2,136
Milliken Ave. - Rochester Ave.	3,976	0	0	120	1,380	1,300	0	0	0	2,800	616	336	224	1,176
Rochester Ave. - Etiwanda Ave.	4,706	0	0	144	1,610	1,560	0	0	0	3,314	729	398	265	1,392
Etiwanda Ave. - E. City Limit	3,976	0	0	120	1,380	1,300	0	0	0	2,800	616	336	224	1,176
TOTAL -- ARROW ROUTE	36,111	0	0	1,080	12,650	11,700	0	0	0	25,430	5,595	3,052	2,034	10,681
4TH STREET ^{Creek}														
Cucamonga St. - Archibald Ave.	2,718	0	0	84	920	910	0	0	0	1,914	421	230	153	804
Archibald Ave. - Haven Ave.	6,492	0	0	192	2,300	2,080	0	0	0	4,572	1,006	549	366	1,920
Haven Ave. - Milliken Ave.	6,492	0	0	192	2,300	2,080	0	0	0	4,572	1,006	549	366	1,920
Milliken Ave. - Etiwanda Ave.	12,783	0	0	372	4,600	4,030	0	0	0	9,002	1,980	1,080	720	3,781
TOTAL -- 4TH STREET	28,485	0	0	840	10,120	9,100	0	0	0	20,060	4,413	2,407	1,605	8,425

BIKEWAY COST ESTIMATES -- CLASS II

LAST REVISED: 28-JUN-1991

CLASSIFICATION/LOCATION	TOTAL COST	CONSTRUCTION COSTS								TOTAL CONST. COST	OTHER COSTS (% TOTAL CONST. COST)			TOTAL OTHER COST
		LAND ACQ.	PAVEMENT PAVEMENT	PAVEMENT MARKINGS	PAVEMENT LANE LINES	SIGNAGE	LIGHTING	UNDER-CROSSINGS AT ROADS	SIGNAL CROSSINGS		ADMIN. (22%)	DESIGN (12%)	INSP. (8%)	
PIONEER WAY														
Rochester Ave. - Pioneer Way	2,190	0	0	72	690	780	0	0	0	1,542	339	185	123	648
TOTAL -- PIONEER WAY	2,190	0	0	72	690	780	0	0	0	1,542	339	185	123	648
GRAND TOTAL	198,042	0	0	5,916	69,460	64,090	0	0	0	139,466	30,683	16,736	11,157	58,576

BIKEWAY COST ESTIMATES -- CLASS III

LAST REVISED: 28-JUN-1991

CLASSIFICATION/LOCATION	CONSTRUCTION COSTS									TOTAL CONST. COST	OTHER COSTS (% TOTAL CONST. COST)			TOTAL OTHER COST
	TOTAL COST	LAND ACQ.	PAVEMENT	PAVEMENT MARKINGS	PAVEMENT LANE LINES	SIGNAGE	LIGHTING	UNDER- CROSSINGS AT ROADS	SIGNAL CROSSINGS		TOTAL CONST. COST	ADMIN. (22%)	DESIGN (12%)	
ARCHIBALD AVENUE														
N. City Limit - Wilson Ave.	3,226	0	0	192	0	2,080	0	0	0	2,272	500	273	182	954
Wilson Ave. - 19th St.	4,234	0	0	252	0	2,730	0	0	0	2,982	656	358	239	1,252
19th St. - Base Line	2,621	0	0	156	0	1,690	0	0	0	1,846	406	222	148	775
Base Line - Foothill Blvd.	3,226	0	0	192	0	2,080	0	0	0	2,272	500	273	182	954
Foothill Blvd. - Arrow Route	1,815	0	0	108	0	1,170	0	0	0	1,278	281	153	102	537
Arrow Route - 4th St.	4,839	0	0	288	0	3,120	0	0	0	3,408	750	409	273	1,431
TOTAL -- ARCHIBALD AVENUE	19,962	0	0	1,188	0	12,870	0	0	0	14,058	3,093	1,687	1,125	5,904
MILLIKEN AVENUE														
Wilson Ave. - Highland Ave.	3,226	0	0	192	0	2,080	0	0	0	2,272	500	273	182	954
Highland Ave. - Base Line	3,226	0	0	192	0	2,080	0	0	0	2,272	500	273	182	954
Base Line - Foothill Blvd.	3,226	0	0	192	0	2,080	0	0	0	2,272	500	273	182	954
Foothill Blvd. - Arrow Route	1,815	0	0	108	0	1,170	0	0	0	1,278	281	153	102	537
Arrow Route - 4th Street	4,839	0	0	288	0	3,120	0	0	0	3,408	750	409	273	1,431
TOTAL -- MILLIKEN AVENUE	16,333	0	0	972	0	10,530	0	0	0	11,502	2,530	1,380	920	4,831
WILSON AVENUE														
Haven Ave. - Milliken Ave.	3,226	0	0	192	0	2,080	0	0	0	2,272	500	273	182	954
Milliken Ave. - Rochester Ave.	2,621	0	0	156	0	1,690	0	0	0	1,846	406	222	148	775
Rochester Ave. - Day Creek	2,420	0	0	144	0	1,560	0	0	0	1,704	375	204	136	716
TOTAL -- WILSON AVENUE	8,267	0	0	492	0	5,330	0	0	0	5,822	1,281	699	466	2,445
HIGHLAND AVENUE														
19th St. - Milliken Ave.	1,210	0	0	72	0	780	0	0	0	852	187	102	68	358
Milliken Ave. - Rochester Ave.	2,621	0	0	156	0	1,690	0	0	0	1,846	406	222	148	775
Rochester - E. of future Day Creek	1,411	0	0	84	0	910	0	0	0	994	219	119	80	417
E. of future Day Creek - Etiwanda	3,025	0	0	180	0	1,950	0	0	0	2,130	469	256	170	895
Etiwanda Ave. - E. City Limit	4,436	0	0	264	0	2,860	0	0	0	3,124	687	375	250	1,312
TOTAL -- HIGHLAND AVENUE	12,703	0	0	756	0	8,190	0	0	0	8,946	1,968	1,074	716	3,757
VICTORIA STREET														
W. of Etiwanda Ave. - E. City Limit	3,630	0	0	216	0	2,340	0	0	0	2,556	562	307	204	1,074
TOTAL -- VICTORIA STREET	3,630	0	0	216	0	2,340	0	0	0	2,556	562	307	204	1,074

BIKEWAY COST ESTIMATES -- CLASS III

LAST REVISED: 28-JUN-1991

CLASSIFICATION/LOCATION	TOTAL COST	CONSTRUCTION COSTS								TOTAL CONST. COST	OTHER COSTS (% TOTAL CONST. COST)			TOTAL OTHER COST
		LAND ACQ.	PAVEMENT MARKINGS	PAVEMENT LANE	PAVEMENT LINES	SIGNAGE	LIGHTING	UNDER-CROSSINGS AT ROADS	SIGNAL CROSSINGS		ADMIN. (22%)	DESIGN (12%)	INSP. (8%)	
CHURCH STREET														
Hellman Ave. - Haven Ave.	5,041	0	0	300	0	3,250	0	0	0	3,550	781	426	284	1,491
Haven Ave. - Rochester Ave.	5,646	0	0	336	0	3,640	0	0	0	3,976	875	477	318	1,670
TOTAL -- CHURCH STREET	10,687	0	0	636	0	6,890	0	0	0	7,526	1,656	903	602	3,161
TERRA VISTA PARKWAY WEST														
Church St. - Milliken Ave.	3,025	0	0	180	0	1,950	0	0	0	2,130	469	256	170	895
TOTAL -- TERRA VISTA PARKWAY WEST	3,025	0	0	180	0	1,950	0	0	0	2,130	469	256	170	895
TERRA VISTA PARKWAY EAST														
Milliken Ave. - Church St.	2,420	0	0	144	0	1,560	0	0	0	1,704	375	204	136	716
TOTAL -- TERRA VISTA PARKWAY EAST	2,420	0	0	144	0	1,560	0	0	0	1,704	375	204	136	716
BERYL STREET														
Hillside St. - Banyan St.	2,621	0	0	156	0	1,690	0	0	0	1,846	406	222	148	775
Banyan St. - 19th St.	2,621	0	0	156	0	1,690	0	0	0	1,846	406	222	148	775
19th St. - Base Line	2,621	0	0	156	0	1,690	0	0	0	1,846	406	222	148	775
TOTAL -- BERYL STREET	7,864	0	0	468	0	5,070	0	0	0	5,538	1,218	665	443	2,326
HAVEN AVENUE														
Hillside St. - Wilson Ave.	807	0	0	48	0	520	0	0	0	568	125	68	45	239
Banyan St. - 19th St.	1,210	0	0	72	0	780	0	0	0	852	187	102	68	358
TOTAL -- HAVEN AVENUE	2,016	0	0	120	0	1,300	0	0	0	1,420	312	170	114	596
HILLSIDE STREET														
W. City Limit - Carnelian Ave.	3,831	0	0	228	0	2,470	0	0	0	2,698	594	324	216	1,133
Carnelian St. - Archibald Ave.	4,234	0	0	252	0	2,730	0	0	0	2,982	656	358	239	1,252
Archibald Ave. - Haven Ave.	3,226	0	0	192	0	2,080	0	0	0	2,272	500	273	182	954
TOTAL -- HILLSIDE STREET	11,292	0	0	672	0	7,280	0	0	0	7,952	1,749	954	636	3,340

BIKEWAY COST ESTIMATES -- CLASS III

LAST REVISED: 28-JUN-1991

CLASSIFICATION/LOCATION	TOTAL COST	CONSTRUCTION COSTS								TOTAL CONST. COST	OTHER COSTS (% TOTAL CONST. COST)			TOTAL OTHER COST
		LAND ACQ.	PAVEMENT	PAVEMENT MARKINGS	PAVEMENT LANE LINES	SIGNAGE	LIGHTING	UNDER-CROSSINGS AT ROADS	SIGNAL CROSSINGS		ADMIN. (22%)	DESIGN (12%)	INSP. (8%)	
BANYAN STREET														
W. City Limit - Carnelian St.	3,226	0	0	192	0	2,080	0	0	0	2,272	500	273	182	954
Carnelian St. - Archibald Ave.	4,234	0	0	252	0	2,730	0	0	0	2,982	656	358	239	1,252
Haven Ave. - Milliken Ave.	3,226	0	0	192	0	2,080	0	0	0	2,272	500	273	182	954
Milliken Ave. - Day Creek Blvd.	3,226	0	0	192	0	2,080	0	0	0	2,272	500	273	182	954
TOTAL -- BANYAN STREET	13,913	0	0	828	0	8,970	0	0	0	9,798	2,156	1,176	784	4,115
SOUTH OF BANYAN STREET														
Archibald Ave. - Haven Ave.	3,226	0	0	192	0	2,080	0	0	0	2,272	500	273	182	954
TOTAL -- SOUTH OF BANYAN STREET	3,226	0	0	192	0	2,080	0	0	0	2,272	500	273	182	954
ARROW ROUTE														
W. City Limit - Baker Avenue	2,016	0	0	120	0	1,300	0	0	0	1,420	312	170	114	596
TOTAL -- ARROW ROUTE	2,016	0	0	120	0	1,300	0	0	0	1,420	312	170	114	596
GRAND TOTAL	117,354	0	0	6,984	0	75,660	0	0	0	82,644	18,182	9,917	6,612	34,710

HIKING AND RIDING TRAILS COST ESTIMATES
REGIONAL MULTI-PURPOSE

LAST REVISED: 19-MAR-1991

CLASSIFICATION/LOCATION	TOTAL COST	CONSTRUCTION COSTS							TOTAL CONST. COST	OTHER COSTS (% TOTAL CONST. COST)			TOTAL OTHER COST
		GRADING	DECOMPOSED REDWOOD		FENCING AT		UNDER-CROSSINGS AT ROADS	ADMIN. (22%)		DESIGN (12%)	INSP. (8%)		
			GRANITE	HEADER	HAZARD AREAS	SIGNAGE						LIGHTING	
CUCAMONGA CREEK													
N. City Limits - 19th Street	410,579	52,800	66,000	0	2,340	0	168,000	0	289,140	63,611	34,697	23,131	121,439
19th Street - Base Line	62,636	19,200	24,000	0	910	0	0	0	44,110	9,704	5,293	3,529	18,526
Base Line - Foothill Blvd.	86,009	26,400	33,000	0	1,170	0	0	0	60,570	13,325	7,268	4,846	25,439
Foothill Blvd. - Arrow Route	39,263	12,000	15,000	0	650	0	0	0	27,650	6,083	3,318	2,212	11,613
Arrow Route - 4th Street	140,793	43,200	54,000	0	1,950	0	0	0	99,150	21,813	11,898	7,932	41,643
TOTAL -- CUCAMONGA CREEK	739,280	153,600	192,000	0	7,020	0	168,000	0	520,620	114,536	62,474	41,650	218,660
ALMOND INTERCEPT CHANNEL													
Cucamonga Creek - Almond Avenue	111,016	14,400	18,000	0	780	0	45,000	0	78,180	17,200	9,382	6,254	32,836
TOTAL -- ALMOND INTERCEPT CHANNEL	111,016	14,400	18,000	0	780	0	45,000	0	78,180	17,200	9,382	6,254	32,836
DEMENS CHANNEL													
Rural Area N of City Lmt-N City Limit	41,450	4,800	6,000	0	390	0	18,000	0	29,190	6,422	3,503	2,335	12,260
N. City Limit - Cucamonga Creek	3,943,425	67,200	84,000	0	2,860	10,000	213,000	2,400,000	2,777,060	610,953	333,247	222,165	1,166,365
TOTAL -- DEMENS CHANNEL	3,984,875	72,000	90,000	0	3,250	10,000	231,000	2,400,000	2,806,250	617,375	336,750	224,500	1,178,625
WOODS TRAIL													
Dam Basin - Deer Creek Channel (Developed & Dedicated)	0	0	0	0	0	0	0	0	0	0	0	0	0
TOTAL -- WOODS TRAIL	0	0	0	0	0	0	0	0	0	0	0	0	0
HILLSIDE CHANNEL													
Dam Basin - Deer Creek Channel	299,748	38,400	48,000	0	1,690	0	123,000	0	211,090	46,440	25,331	16,887	88,658
TOTAL -- HILLSIDE CHANNEL	299,748	38,400	48,000	0	1,690	0	123,000	0	211,090	46,440	25,331	16,887	88,658
DEER CREEK													
Deer Creek - Highland Avenue	3,670,927	33,600	42,000	0	1,560	0	108,000	2,400,000	2,585,160	568,735	310,219	206,813	1,085,767
Highland Avenue - Base Line	78,341	24,000	30,000	0	1,170	0	0	0	55,170	12,137	6,620	4,414	23,171
Base Line - Foothill Blvd.	93,862	28,800	36,000	0	1,300	0	0	0	66,100	14,542	7,932	5,288	27,762
Foothill Blvd. - Arrow Route	39,263	12,000	15,000	0	650	0	0	0	27,650	6,083	3,318	2,212	11,613
Arrow Route - 4th Street	117,235	36,000	45,000	0	1,560	0	0	0	82,560	18,163	9,907	6,605	34,675
TOTAL -- DEER CREEK	3,999,629	134,400	168,000	0	6,240	0	108,000	2,400,000	2,816,640	619,661	337,997	225,331	1,182,989

HIKING AND RIDING TRAILS COST ESTIMATES
REGIONAL MULTI-PURPOSE

LAST REVISED: 19-MAR-1991

CLASSIFICATION/LOCATION	TOTAL COST	CONSTRUCTION COSTS							TOTAL CONST. COST	OTHER COSTS (% TOTAL CONST. COST)			TOTAL OTHER COST
		GRADING	DECOMPOSED REDWOOD		FENCING AT HAZARD		UNDER-CROSSINGS AT ROADS	ADMIN. (22%)		DESIGN (12%)	INSP. (8%)		
			GRANITE	HEADER	SIGNAGE	AREAS						LIGHTING	
DAY CREEK													
Rural Area N of City Lmt-N City Lmt	357,201	45,600	57,000	0	1,950	0	147,000	0	251,550	55,341	30,186	20,124	105,651
N. City Limit - Highland Avenue	3,670,927	33,600	42,000	0	1,560	0	108,000	2,400,000	2,585,160	568,735	310,219	206,813	1,085,767
Highland Avenue - Base Line	78,341	24,000	30,000	0	1,170	0	0	0	55,170	12,137	6,620	4,414	23,171
Base Line - Foothill Blvd.	78,341	24,000	30,000	0	1,170	0	0	0	55,170	12,137	6,620	4,414	23,171
Foothill Blvd. - Arrow Route	39,263	12,000	15,000	0	650	0	0	0	27,650	6,083	3,318	2,212	11,613
Arrow Route - 4th Street	117,235	36,000	45,000	0	1,560	0	0	0	82,560	18,163	9,907	6,605	34,675
TOTAL -- DAY CREEK	4,341,309	175,200	219,000	0	8,060	0	255,000	2,400,000	3,057,260	672,597	366,871	244,581	1,284,049
FRONTLINE REGIONAL TRAIL													
W. City Limit - E. City Limit	263,126	139,200	0	0	2,600	43,500	0	0	185,300	40,766	22,236	14,824	77,826
TOTAL -- FRONTLINE REGIONAL TRAIL	263,126	139,200	0	0	2,600	43,500	0	0	185,300	40,766	22,236	14,824	77,826
GRAND TOTAL	13,738,983	727,200	735,000	0	29,640	53,500	930,000	7,200,000	9,675,340	2,128,575	1,161,041	774,027	4,063,643

HIKING AND RIDING TRAILS COST ESTIMATES
COMMUNITY TRAILS

LAST REVISED: 28-Oct-91

CLASSIFICATION/LOCATION	TOTAL COST	CONSTRUCTION COSTS							TOTAL CONST. COST	OTHER COSTS (% TOTAL CONST. COST)			TOTAL OTHER COST
		LAND ACQ.	DEMOLITION & RECON-STRUCTION	GRADING	DECOMPOSED GRANITE SURFACE	SIGNAGE	FENCING & CONCRETE CURB	BRIDGES		ADMIN. (22%)	DESIGN (12%)	INSP. (8%)	
TURQUOISE AVENUE													
Almond Street - Banyan Street	521,992	0	37,500	28,800	36,000	1,300	264,000	0	367,600	80,872	44,112	29,408	154,392
TOTAL -- TURQUOISE AVENUE	521,992	0	37,500	28,800	36,000	1,300	264,000	0	367,600	80,872	44,112	29,408	154,392
SAPPHIRE STREET													
Almond Street - Banyan Street	418,332	0	16,500	28,800	36,000	1,300	212,000	0	294,600	64,812	35,352	23,568	123,732
TOTAL -- SAPPHIRE STREET	418,332	0	16,500	28,800	36,000	1,300	212,000	0	294,600	64,812	35,352	23,568	123,732
TOPAZ CHANNEL													
Almond Street - Demens Channel	271,376	0	0	19,200	24,000	910	147,000	0	191,110	42,044	22,933	15,289	80,266
TOTAL -- TOPAZ CHANNEL	271,376	0	0	19,200	24,000	910	147,000	0	191,110	42,044	22,933	15,289	80,266
CARNELIAN STREET													
Almond Street - Banyan Street	362,242	0	42,000	28,800	36,000	1,300	147,000	0	255,100	56,122	30,612	20,408	107,142
TOTAL -- CARNELIAN STREET	362,242	0	42,000	28,800	36,000	1,300	147,000	0	255,100	56,122	30,612	20,408	107,142
BERYL STREET													
Reales Street - Banyan Street	307,572	0	9,500	28,800	36,000	1,300	141,000	0	216,600	47,652	25,992	17,328	90,972
TOTAL -- BERYL STREET	307,572	0	9,500	28,800	36,000	1,300	141,000	0	216,600	47,652	25,992	17,328	90,972
AMETHYST STREET													
Almond Street - Banyan Street	528,382	0	42,000	28,800	36,000	1,300	264,000	0	372,100	81,862	44,652	29,768	156,282
TOTAL -- DAY CREEK	528,382	0	42,000	28,800	36,000	1,300	264,000	0	372,100	81,862	44,652	29,768	156,282
ARCHIBALD AVENUE													
Frontline Reg. Trail - Banyan St.	507,820	0	36,000	40,800	51,000	1,820	228,000	0	357,620	78,676	42,914	28,610	150,200
TOTAL -- ARCHIBALD AVENUE	507,820	0	36,000	40,800	51,000	1,820	228,000	0	357,620	78,676	42,914	28,610	150,200
ALTA LOMA STORM DRAIN CHANNEL													
Almond Trail - Banyan Street	144,315	0	0	31,200	39,000	1,430	5,000	25,000	101,630	22,359	12,196	8,130	42,685
TOTAL -- ALTA LOMA STORM DRAIN	144,315	0	0	31,200	39,000	1,430	5,000	25,000	101,630	22,359	12,196	8,130	42,685

HIKING AND RIDING TRAILS COST ESTIMATES
COMMUNITY TRAILS

LAST REVISED: 28-Oct-91

CLASSIFICATION/LOCATION	TOTAL COST	CONSTRUCTION COSTS							TOTAL CONST. COST	OTHER COSTS (% TOTAL CONST. COST)			TOTAL OTHER COST
		LAND ACQ.	DEMOLITION & RECON- STRUCTION	GRADING	DECOMPOSED GRANITE SURFACE	SIGNAGE	FENCING & CONCRETE CURB	BRIDGES		ADMIN. (22%)	DESIGN (12%)	INSP. (8%)	
TIPU PLACE													
Victoria Windrows N. - So. Pac. RR	109,496	0	0	6,720	8,400	390	61,600	0	77,110	16,964	9,253	6,169	32,386
TOTAL -- TIPU PLACE	109,496	0	0	6,720	8,400	390	61,600	0	77,110	16,964	9,253	6,169	32,386
CORNWALL TRAIL (SCE CORRIDOR)													
East Ave. - Foothill Blvd.	195,463	0	0	12,000	15,000	650	110,000	0	137,650	30,283	16,518	11,012	57,813
Foothill Blvd. - Arrow Route	117,278	0	0	7,200	9,000	390	66,000	0	82,590	18,170	9,911	6,607	34,688
TOTAL -- CORNWALL TRAIL	312,741	0	0	19,200	24,000	1,040	176,000	0	220,240	48,453	26,429	17,619	92,501
ALMOND TRAIL													
Cucamonga Creek - Sapphire St.	117,278	0	0	7,200	9,000	390	66,000	0	82,590	18,170	9,911	6,607	34,688
Sapphire St. - Carnelian St.	195,463	0	0	12,000	15,000	650	110,000	0	137,650	30,283	16,518	11,012	57,813
Carnelian St. - Beryl St. (Reales)	228,123	23,000	0	12,000	15,000	650	110,000	0	160,650	35,343	19,278	12,852	67,473
Beryl St. - Amethyst Ave.	117,278	0	0	7,200	9,000	390	66,000	0	82,590	18,170	9,911	6,607	34,688
Amethyst Ave. - Archibald Ave.	156,370	0	0	9,600	12,000	520	88,000	0	110,120	24,226	13,214	8,810	46,250
Archibald Ave. - Hermosa Ave.	234,556	0	0	14,400	18,000	780	132,000	0	165,180	36,340	19,822	13,214	69,376
Hermosa Ave. - Hillside Channel	156,370	0	0	9,600	12,000	520	88,000	0	110,120	24,226	13,214	8,810	46,250
TOTAL -- ALMOND TRAIL	1,205,438	23,000	0	72,000	90,000	3,900	650,000	0	848,900	186,758	101,868	67,912	356,538
HILLSIDE ROAD													
Cucamonga Creek - Sapphire St.	261,536	10,000	9,000	14,400	18,000	780	132,000	0	184,180	40,520	22,102	14,734	77,356
Sapphire St. - Carnelian St.	292,776	18,000	23,000	14,400	18,000	780	132,000	0	206,180	45,360	24,742	16,494	86,596
Carnelian St. - Hellman Ave.	311,804	12,000	15,000	16,800	21,000	780	154,000	0	219,580	48,308	26,350	17,566	92,224
Hellman Ave. - Archibald Ave.	253,726	9,000	4,500	14,400	18,000	780	132,000	0	178,680	39,310	21,442	14,294	75,046
Archibald Ave. - Hermosa Ave.	208,953	5,000	4,500	12,000	15,000	650	110,000	0	147,150	32,373	17,658	11,772	61,803
Hermosa Ave. - Haven Ave.	225,283	9,000	12,000	12,000	15,000	650	110,000	0	158,650	34,903	19,038	12,692	66,633
Haven Ave. - Deer Creek	379,339	0	19,500	21,600	27,000	1,040	198,000	0	267,140	58,771	32,057	21,371	112,199
TOTAL -- HILLSIDE ROAD	1,933,415	63,000	87,500	105,600	132,000	5,460	968,000	0	1,361,560	299,543	163,387	108,925	571,855
WILSON TRAIL													
Cucamonga Creek - Sapphire St.	414,896	124,000	3,000	14,400	18,000	780	132,000	0	292,180	64,280	35,062	23,374	122,716
Sapphire St. - Carnelian St.	536,178	269,000	1,000	7,200	9,000	390	66,000	25,000	377,590	83,070	45,311	30,207	158,588
Carnelian St. - Beryl St.	201,853	0	15,500	12,000	15,000	650	99,000	0	142,150	31,273	17,058	11,372	59,703
Beryl St. - Hellman Ave.	78,370	0	0	4,800	6,000	390	44,000	0	55,190	12,142	6,623	4,415	23,180
Hellman Ave. - Archibald Ave.	234,556	0	0	14,400	18,000	780	132,000	0	165,180	36,340	19,822	13,214	69,376
Archibald Ave. - Hermosa Ave.	117,363	0	0	12,000	15,000	650	55,000	0	82,650	18,183	9,918	6,612	34,713
Hermosa Ave. - Haven Ave.	242,366	0	5,500	14,400	18,000	780	132,000	0	170,680	37,550	20,482	13,654	71,686
Haven Ave. - Deer Creek	380,872	0	25,500	22,080	27,600	1,040	167,000	25,000	268,220	59,008	32,186	21,458	112,652
Deer Creek - Milliken Ave.	83,411	0	0	2,880	3,600	260	27,000	25,000	58,740	12,923	7,049	4,599	24,671
Milliken Ave. - Rochester Ave.	312,556	0	0	19,200	24,000	910	176,000	0	220,110	48,424	26,413	17,609	92,446
Rochester Ave. - Etiwanda Ave.	468,742	0	0	28,800	36,000	1,300	264,000	0	330,100	72,622	39,612	26,408	138,642
Etiwanda Ave. - East Ave.	234,556	0	0	14,400	18,000	780	132,000	0	165,180	36,340	19,822	13,214	69,376
East Ave. - E. City Limit	664,020	0	0	40,800	51,000	1,820	374,000	0	467,620	102,876	56,114	37,410	196,400
TOTAL -- WILSON TRAIL	3,969,738	393,000	50,500	207,360	259,200	10,530	1,800,000	75,000	2,795,590	615,030	335,471	223,647	1,174,148

HIKING AND RIDING TRAILS COST ESTIMATES
COMMUNITY TRAILS

LAST REVISED: 28-Oct-91

CLASSIFICATION/LOCATION	TOTAL COST	LAND ACQ.	DEMOLITION & RECONSTRUCTION	CONSTRUCTION COSTS					TOTAL CONST. COST	OTHER COSTS (% TOTAL CONST. COST)			TOTAL OTHER COST
				GRADING	DECOMPOSED GRANITE SURFACE	SIGNAGE	FENCING & CONCRETE CURB	BRIDGES		ADMIN. (22%)	DESIGN (12%)	INSP. (8%)	
BANYAN STREET													
Cucamonga Creek - Sapphire St.	47,130	0	0	4,800	6,000	390	22,000	0	33,190	7,302	3,983	2,655	13,940
Sapphire St. - Carnelian St.	236,643	14,000	15,000	12,000	15,000	650	110,000	0	166,650	36,663	19,998	13,332	69,993
Carnelian St. - Hellman Ave.	331,016	6,000	7,000	19,200	24,000	910	176,000	0	239,110	51,284	27,973	18,649	97,906
Hellman Ave. - Archibald Ave.	230,963	11,000	14,000	12,000	15,000	650	110,000	0	162,650	35,783	19,518	13,012	68,313
Archibald Ave. - Hermosa Ave.	205,403	4,000	3,000	12,000	15,000	650	110,000	0	144,650	31,823	17,358	11,572	60,753
Hermosa Ave. - Haven Ave.	358,763	115,000	0	12,000	15,000	650	110,000	0	252,650	55,583	30,318	20,212	106,113
Haven Ave. - Milliken Ave.	373,701	0	0	24,000	30,000	1,170	183,000	25,000	263,170	57,897	31,580	21,054	110,531
Milliken Ave. - Rochester Ave.	312,556	0	0	19,200	24,000	910	176,000	0	220,110	48,424	26,413	17,609	92,446
Rochester Ave. - W. of Etiwanda Ave.	504,242	0	0	28,800	36,000	1,300	264,000	25,000	355,100	78,122	42,612	28,408	149,142
TOTAL -- BANYAN STREET	2,600,418	150,000	39,000	144,000	180,000	7,280	1,261,000	50,000	1,831,280	402,882	219,754	146,502	769,138
LOWER SUMMIT AVENUE													
W. of Etiwanda Ave. - East Ave.	195,463	0	0	12,000	15,000	650	110,000	0	137,650	30,283	16,518	11,012	57,813
East Ave. - Loop	390,741	0	0	24,000	30,000	1,170	220,000	0	275,170	60,537	33,020	22,014	115,571
TOTAL -- LOWER SUMMIT AVENUE	586,204	0	0	36,000	45,000	1,820	330,000	0	412,820	90,820	49,538	33,026	173,384
BLUE GUM TRAIL													
Etiwanda Ave. - East Ave.	156,370	0	0	9,600	12,000	520	88,000	0	110,120	24,226	13,214	8,810	46,250
East Ave. - Loop	326,742	0	0	28,800	36,000	1,300	164,000	0	230,100	50,622	27,612	18,408	96,642
TOTAL -- BLUE GUM TRAIL	483,112	0	0	38,400	48,000	1,820	252,000	0	340,220	74,848	40,826	27,218	142,892
VICTORIA PARK LANE													
Rochester Ave. - Day Creek Blvd.	156,370	0	0	9,600	12,000	520	88,000	0	110,120	24,226	13,214	8,810	46,250
Day Creek - N. Victoria Windrows	78,370	0	0	4,800	6,000	390	44,000	0	55,190	12,142	6,623	4,415	23,180
TOTAL -- VICTORIA PARK LANE	234,740	0	0	14,400	18,000	910	132,000	0	165,310	36,368	19,837	13,225	69,430
N. VICTORIA WINDROWS LOOP													
Victoria Park Lane - E. of Tipu Pl.	78,370	0	0	4,800	6,000	390	44,000	0	55,190	12,142	6,623	4,415	23,180
TOTAL -- N. VICTORIA WINDROWS LOOP	78,370	0	0	4,800	6,000	390	44,000	0	55,190	12,142	6,623	4,415	23,180
CHURCH STREET													
Rochester Ave. - Day Creek Channel	117,278	0	0	7,200	9,000	390	66,000	0	82,590	18,170	9,911	6,607	34,688
TOTAL -- CHURCH STREET	117,278	0	0	7,200	9,000	390	66,000	0	82,590	18,170	9,911	6,607	34,688
MILLER AVENUE													
Day Creek Channel - Day Creek Blvd.	78,370	0	0	4,800	6,000	390	44,000	0	55,190	12,142	6,623	4,415	23,180
Day Creek-Victoria Pk. (mid-block)	117,278	0	0	7,200	9,000	390	66,000	0	82,590	18,170	9,911	6,607	34,688
TOTAL -- MILLER AVENUE	195,648	0	0	12,000	15,000	780	110,000	0	137,780	30,312	16,534	11,022	57,868

HIKING AND RIDING TRAILS COST ESTIMATES
COMMUNITY TRAILS

LAST REVISED: 28-Oct-91

CLASSIFICATION/LOCATION	TOTAL COST	CONSTRUCTION COSTS							TOTAL CONST. COST	OTHER COSTS (% TOTAL CONST. COST)			TOTAL OTHER COST
		LAND ACQ.	DEMOLITION & RECON-STRUCTION	GRADING	DECOMPOSED GRANITE SURFACE	SIGNAGE	FENCING & CONCRETE CURB	BRIDGES		ADMIN. (22%)	DESIGN (12%)	INSP. (8%)	
SOUTHERN PACIFIC RAILROAD													
W. City Limit - Grove Ave.	117,278	0	0	7,200	9,000	390	66,000	0	82,590	18,170	9,911	6,607	34,688
Grove Ave. - Base Line	859,299	0	0	52,800	66,000	2,340	484,000	0	605,140	133,131	72,617	48,411	254,159
Base Line - Archibald Ave.	195,463	0	0	12,000	15,000	650	110,000	0	137,650	30,283	16,518	11,012	57,813
Archibald Ave. - Haven Ave.	390,741	0	0	24,000	30,000	1,170	220,000	0	275,170	60,537	33,020	22,014	115,571
Haven Ave. - Milliken Ave.	390,741	0	0	24,000	30,000	1,170	220,000	0	275,170	60,537	33,020	22,014	115,571
Milliken Ave. - Rochester Ave.	312,556	0	0	19,200	24,000	910	176,000	0	220,110	48,424	26,413	17,609	92,446
Rochester Ave. - Etiwanda Ave.	507,835	0	0	31,200	39,000	1,430	286,000	0	357,630	78,679	42,916	28,610	150,205
Etiwanda Ave. - E. City Limit	273,464	0	0	16,800	21,000	780	154,000	0	192,580	42,368	23,110	15,406	80,884
TOTAL -- SOUTHERN PACIFIC RAILROAD	3,047,377	0	0	187,200	234,000	8,840	1,716,000	0	2,146,040	472,129	257,525	171,683	901,337
GRAND TOTAL	21,012,265	633,000	405,000	1,294,080	1,617,600	64,090	10,633,600	150,000	14,797,370	3,255,421	1,775,684	1,183,790	6,214,895

9.2 FINANCING PLAN



AGAJANIAN
& ASSOCIATES

Development Economic
& Planning Consultants

TRAIL FINANCING STRATEGY Rancho Cucamonga, California

Prepared for:

City of Rancho Cucamonga
10500 Civic Center Drive
Rancho Cucamonga, California 91730

May 2, 1991

800 Newport Center Drive
Suite 475
Newport Beach, CA 92660
(714) 640-0664
FAX (714) 640-0665

9.2 TRAIL FINANCING STRATEGY

The purpose of this report is to present a recommended financing strategy for the bicycle, equestrian and hiking trail system proposed in the draft Trail Implementation Plan (TIP) for Rancho Cucamonga, California. This financing strategy identifies specific recommended actions that the City may undertake to implement trail improvements over a long term planning period.

More specifically, this report compiles, describes, evaluates and selects potential sources of funding available to acquire, improve, maintain and manage the proposed trail system. The trail financing strategy and recommended implementation actions in this report have been formulated to optimize the available funding sources in meeting the needs outlined in the draft Trail Implementation Plan.

The recommended financing strategy in this report is presented in three sections. Initially, the funding needs of the draft TIP trail system are assessed in order to determine the amount and type of funding required. The broad range of financing sources are then evaluated in order to identify reasonably available sources to finance trail implementation. Finally, a financing strategy is formulated to optimize trail implementation with available financing sources.

A. TRAIL PLAN IMPLEMENTATION COSTS

The draft TIP identifies four major categories of trail implementation costs which will require some form of financing. These categories of costs include the acquisition of land or easements, the construction of new facilities, the ongoing maintenance of the trails, and the ongoing management of the trail system. Each of these separate cost categories can be described with regard to their scope and the kind of financing source most suitable for its needs as follows:

Trail Acquisition Costs

This covers the revenues and resources necessary to secure the land or

rights in order for the public to access and use the trails. Trail acquisition costs can be considered as capital costs.

Trail Improvement Costs

This covers the capital costs associated with the physical improvements of the trails and includes trail surfacing/stripping, grading, bridges/underpasses, trail head facilities, appurtenances (fences, signs, gates, lighting) and equestrian facilities. In addition, service costs covering the design, plan check coordination and construction inspection are included as part of the trail improvement costs. Improvement costs will account for a large share of the funding required to implement the trail system.

Trail Maintenance Costs

These costs are needed on an ongoing basis to provide regularly scheduled and emergency trail maintenance including trail surfacing/maintenance, replacement of appurtenances, sweeping/clearance and weed abatement. These services are provided by the city for all public trails and are expected to continue to be provided by the city. A reliable annual source of revenues can best meet these needs.

Management Service Costs

This covers the costs for planning, administration, inspection, enforcement and promotion of the current and proposed trail system. It is anticipated that city staff will provide these services. Management services will require recurring revenues and resources on an ongoing basis.

These four cost categories can be combined into capital costs needs (acquisition and improvements) and recurring costs needs (trail maintenance and management).

1. Capital Costs

The estimated costs for each capital cost category has been prepared in order to establish the magnitude of all trail costs that need to be financed. The most extensive and detailed trail cost estimates have been prepared for the land acquisition and trail development categories. These estimates are presented in the Appendix to the draft TIP for each individual trail and component trail segment. The detailed cost estimates for acquisition and development are summarized on Table 1 in order to quantify the total capital funding requirements for the draft TIP.

From the summary of costs on Table 1 we may observe that in excess of \$75,000,000 will be needed to acquire and develop the trails identified in the draft TIP. This total cost is nearly all associated with construction of the

trails. Over \$52,000,000 of the development costs are hard costs needed to physically construct the trail improvement. Over \$22,000,000 of the development costs are soft costs needed to design, administer and inspect the trail construction. Land Acquisition accounts for about \$633,000 of development costs, representing less than 2% of all capital costs.

The bicycle and hiking and equestrian trail system will each require about half of all the needed capital costs. The bicycle trail system is estimated to need about \$38,000,000 in development costs. Bicycle trails are not expected to require any land acquisition costs. Of the entire bicycle trail system, Class I bikeways account for over 99% of the needed capital costs. Furthermore, \$32,376,000 of all Class I Bikeway capital costs are needed to construct 23 street undercrossings each valued at \$1,200,000 each. Thus, we may observe that Class I bikeways account for 99% of all bikeway capital needs and that street undercrossing facilities account for 85% of all Class I capital requirements. In other words, the construction of the entire bicycle trail system would require about \$5,616,000 in capital funding without the street undercrossings.

The H/E trail system has different capital requirements than the bicycle trails. The H/E trails system has some need to acquire land and/or easements. However, land acquisition costs account for less than 3% of all H/E development costs. The bulk of H/E capital costs are associated with the construction of trails. Six street undercrossings are planned for the regional multi-purpose H/E trails and, like the Class I bikeways, account for about 80% of all capital requirements.

The community H/E trails have the greatest share of capital needs for trail construction since this category does not have any expensive street undercrossings included. Consequently, the \$23,500,000 of capital required to develop these trails are needed to implement trail construction and improvements only.

No cost estimates are available for trail landscaping and rehabilitation needs and have not been addressed in this study. Similarly the capital costs for the equestrian facilities, trail heads, and exercise stations which are part of the draft TIP have not been estimated and are also not addressed in this study.

2. Recurring Costs

Costs associated with managing and maintaining the trails are expected to occur annually. The city's current experience with trail maintenance has been limited to 5 miles of bikeways and less than 5 miles of equestrian trails. The nearly 150 miles of private local feeder trails are maintained by the homeowners or the homeowner's association. The Class I bikeway along Cucamonga and Demens Channels receives maintenance on an as needed basis or about once a year, mainly in the form of a fall herbicide spraying.

Class II and Class III bikeways receive sweeping as part of the street sweeping schedule and maintenance is provided on an as needed basis. The equestrian trails are maintained on an as needed basis or once a year when pre-emergent spray is applied.

Because of the limited trail maintenance experience in the city, research was undertaken to supplement local estimates of trail maintenance costs. The research revealed that many cities with extensive trail systems do not keep systematic and separate cost accounts for trail maintenance. Trail maintenance costs are most frequently incorporated into municipal street maintenance and sweeping operations or as part of park maintenance operations.

A composite estimate of trail maintenance costs for the proposed trail system at full development is presented on Table 2 based upon the trail maintenance experience in the cities of Rancho Cucamonga, Palo Alto, Davis, Walnut, San Diego and Boulder, Colorado. These trail maintenance cost estimates exclude consideration of landscaping maintenance due to the lack of a reliable and consistent basis to make such an estimate.

Bikeway trail maintenance costs of \$221,000 per year can be expected for the 34.5 miles of Class I bikeways. This estimate accounts for pavement maintenance of an oil seal every 3 years, a 1 inch slurry seal overlay every 12 years, and once a month sweeping. The Class II and III bikeways are expected to incur only nominal costs since all of the pavement maintenance and sweeping are most efficiently provided by budgeted street and park maintenance operations. A sweeper and a pickup, estimated at \$75,000, will be needed to maintain the new bikeway trails.

H/E trail maintenance costs of \$193,000 per year can be expected for the 97.0 miles of regional and community trails. The maintenance cost of H/E trails is based upon spraying, cleaning and maintaining the decomposed granite surface of the trails 6 times a year. This service level is considerably above the current once per year maintenance.

Trail management costs will cover the staff expenses to monitor trail usage, initiate capital improvements, seek and obtain funding, and advocate trail development and use. This function may involve the skills of city staff from several departments on an as needed basis. However, the bulk of these management functions can be assigned to a part-time or full-time trail coordinator position.

Trail system management is expected to require the equivalent of one full-time trail coordinator staff position at the associate planner level. Presently, such a staff person would earn a salary of \$43,116 and receive about 35% in benefits. Trail management costs are expected to be about \$58,200 annually.

Altogether, it is estimated that about \$352,000 will be required annually to

maintain and manage the entire proposed trail system. These recurring costs may be proportionately reduced if the extent of the trail system is reduced or the service level is reduced.

B. AVAILABLE FINANCING MECHANISMS

In assessing the financing mechanisms available to the city for funding trails it is helpful to first review the broad categories of financing mechanisms and then detail those mechanisms which are most appropriate for the needs. Financing mechanisms used to generate revenues to pay for both capital and recurring municipal trail costs are numerous. However, these many financing mechanisms can be organized into funding sources which share essentially the same characteristics.

There are seven general sources of funding available to implement the proposed trail system:

1. Revenues provided by the city's general fund;
2. Revenues provided by user fees;
3. Revenues provided by the city's special funds;
4. Revenues provided by assessment districts;
5. Contributions provided by individual volunteer donations;
6. In-kind resources provided by city development regulations;
7. Revenues received from state/federal grants.

These seven funding sources have been characterized on Table 3. As can be observed, each funding source contains several financing mechanisms which differ with respect to the type of resource generated, the frequency of receipts, the mechanism's applicability to the specific needs of the trail system, who provides the revenues, and the relative costs to administer the financing mechanism. What is important to note about these funding sources is that each has its own specific purpose and application suited to accomplish one particular financing need. This suggests that the trail financing plan may contain a variety of mechanisms each intended to fulfill a specific trail funding need.

The opportunities and constraints of the major funding sources for application to trail financing in Rancho Cucamonga are presented on Table 4. This evaluation reveals that each funding source has severe limitations due to the resistance of taxpayers, the need of funds for other municipal services and improvements, and competition among many public needs for scarce funding

resources.

Despite the limitations associated with these major funding sources, there are a number of financing mechanisms which appear suitable for trail implementation in Rancho Cucamonga. These particular mechanisms have been selected because they generate new revenues to the city rather than shift existing revenues to trail uses.

1. General Fund Sources

A. Property Transfer Tax

The county currently levies a tax of \$1.10/\$1,000 of assessed valuation on property sales. Of this amount, the city receives half as general fund revenues. The city estimates that it will receive about \$466,000 in fiscal 1990-1991, representing the transfer of nearly \$850 million in assessed valuation (equivalent to the sale of 3,500 homes).

This particular revenue source has been selected for consideration because of its equity and efficiency. It appears reasonable to expect home sellers (or sellers of other properties) to incur an added cost at the time of sale to recapture trail costs which have increased the value of the property due to the provision of a community amenity. The tax is also efficient since it recovers property value increases at the time of sale only (when the property owner has the cash to pay) instead of an annual assessment. Thus, a home seller of a \$250,000 property would be taxed an additional \$25.00 on the sale at a \$0.10/\$1,000 property tax transfer rate.

However, the city may not levy such a tax without state enabling legislation. Obtaining this legislative authority will prove difficult, if not impossible. This low probability of success must be weighed against the potential to generate revenues. This tax source can generate about \$8,500 for every \$0.01 increase of tax per \$1,000 of assessed valuation. Thus, the creation of a \$0.10 property transfer tax surtax would generate about \$85,000 in revenues annually.

B. Retail Sales Tax

Like the property transfer tax, the city could seek to increase the local retail sales tax increment as part of a countywide sales tax increase to fund local recreational facilities. Such a levy would require a vote of the county residents. However, with an estimated retail sales volume of \$508,800,000 in the city, a very small sales tax increment can produce substantial amounts of new revenues for the city. It is estimated that an added 1/4% of sales tax could produce \$1,272,000 in annual revenues. Even a 1/10% increase in sales tax would produce \$508,800 annually. If established for a limited time period (say 5 or 10 years), such a new source of revenues

could assist trail implementation significantly. Unfortunately, such a sales tax increase would require countywide action, making it difficult, if not impossible, to establish.

2. Competitive Trail Improvement Funds

There are a number of state/federal grants which may help provide revenues to construct trail segments in the city. These revenue sources include the following grants:

A. Article 3 - Bikeway/Pedestrian Path Fund

The San Bernardino Association of Governments administers the distribution of roughly \$500,000 annually in SB325 revenues derived from a portion of the 1/4% sales tax collected for transportation improvements. These funds are allocated on a competitive basis throughout the county making the chances of receiving several grants over the next decade very likely. These grants may be able to generate a total of \$250,000 to \$500,000 in capital improvement revenues over a multi-year period.

B. Rail Transportation Bond Act

The recently passed Proposition 116 sets aside \$20,000,000 in revenues to assist commuter bikeway facilities throughout the state. There is no timetable for allocating these revenues. Statewide competition makes the chances of securing significant capital grants limited, but possible.

C. State Bicycle Lane Account

This fund is administered by Caltrans's Local Streets and Road Division. This account fund is limited in its size and its application to commuter bicycle facilities. Statewide competition makes this fund a possible, but not likely, source of capital revenues to implement local trails.

D. Other Grants

There are a number of other state and federal sources of grants. However, they all have limitations and requirements which make them more competitive than those listed above. The chances of securing significant revenues from these other grant sources are considered next to impossible.

3. User Fees

It is always desirable to charge users directly for the public services they consume. However, the city has no reasonable means to assess user fees to bicyclists, pedestrians or horseriders. About 200 bicycle licenses are

issued in the city. Any user fee added to the cost of these licenses would only tend to lower the number of persons obtaining bicycle licenses.

Similarly, any effort to establish or increase a tax upon horses or mules in the city would encourage horse tending residents to avoid registering. Since the maximum tax levy allowed is \$10.00 per horse or mule, this source could generate about \$5,000 annually from the estimated horse population of 500 in the city. But without resident participation such a fee could generate more aggravation than revenues.

Consequently, the use of user fees is limited in the amount and stability of revenues they can generate. However, users can provide other "in-kind" resources with volunteers and donations.

4. Assessment Districts

The best source of continuous revenues occurs in the form of an assessment district which levies a property tax upon all taxable parcels within the city or designated benefit areas. Such an assessment district could conceivably provide all of the revenues needed to implement and maintain the proposed facilities.

Assessment districts could be established to fund bikeways, H/E trails, or the entire proposed trail system. These districts could be established to cover a portion of the city, the entire city, and the city at buildout. The city at buildout would cover the current city (32,173 parcels) along with the 7,569 future parcels in the city's sphere of influence (39,742 total parcels).

Several types of assessment districts are available to implement and maintain the trail system. Three particular types of districts may be established which can both secure capital funds for implementation and generate annual revenues for maintenance. The 1972 Landscaping and Lighting district was amended in 1984 to include recreational facilities, such as the proposed trail system. This type of district has been implemented in other jurisdictions who favor its relatively unobtrusive process which may avoid electoral approval. Under the provisions of this district, the City Council can declare the establishment of the district (based upon a feasibility study) and authorize the district (following hearings) with a majority vote if objections registered by owners do not exceed 50% of all property owners in the proposed district.

A Mello-Roos Community Facility District is another type of assessment district which may be used to implement and maintain the trail system. This type of district would be most appropriate for a newly developing area since the vote for approval may be based upon land ownership (one vote per acre) if there are less than 12 registered voters in the benefit area. Otherwise, voters must approve the district with a two-thirds majority.

Yet another type of assessment district which may be considered is the Integrated Financing District. Such a district was designed to finance public facilities in developing areas. However, such a district may also be used to consolidate several existing districts, such as the landscaping and lighting districts in the developed areas of the city. Other types of assessment districts may be considered at the implementation stage, but these three districts listed appear to offer an appropriate range of options for financing the trail system.

Regardless of the type of assessment district, we can estimate that the entire proposed trail system can be implemented and maintained for \$239 of increased annual property taxes from the city's 32,173 parcels. This includes \$75,000,000 in improvement costs and \$352,000 annually for maintenance. This burden could be reduced to \$193 annually if the assessment district is expanded to cover the future parcels in the city's sphere of influence. Such an onerous property tax levy could be considered unachievable without significant public support for the proposed trail system.

Short of establishing an assessment district to generate all capital needs, smaller districts can be formed to fund only portions of the trail system, such as the community level equestrian trails. The \$23,500,000 needed to implement community H/E trails and the \$106,400 needed annually for their maintenance could be financed by the 6,914 parcels served by the community H/E trails in the Equestrian/Rural Overlay District. In this case, the average parcel would incur \$49 annually in increased property taxes to cover all costs.

Implementation and maintenance costs for the bikeways and the regional H/E trails could be financed on a citywide basis. Under these circumstances, \$51,800,000 of improvements and \$245,241 of annual maintenance costs could be financed with a property tax increase of \$165 per parcel in the city (32,173 parcels) or \$133 per parcel within the city and sphere of influence (39,742 parcels).

In addition, assessment districts can be used to generate annual revenues to help pay for recurring maintenance and management expenses. The city currently has several lighting and landscaping assessment districts established to help pay for street lights and roadway median landscaping. With pending state legislation, the city may be able to consolidate these existing districts into a single large district. Trail maintenance and management responsibilities may be incorporated into the consolidated district.

5. Development Impact Fees

All new development in the city is subject to impact fees which ensure that

new development pays for their pro rata share of capital improvements. In addition to the park fees currently charged, a separate fee for trails may be imposed as a condition of development. Such a trail impact fee could recover a portion of the capital costs for that part of the system which serves the entire city. These would include the bikeways and the Regional H/E trails.

The development fee for the trail system could only finance a portion of the \$51,761,000 capital costs for the bikeways and the Regional H/E trails. Only about \$15,000,000 (30%) of the total amount could be financed with the addition of about 15,000 new homes in the city. The remaining \$36,761,000 would be the responsibility of the 36,400 existing homes in the city. A development fee of about \$1,000 per equivalent dwelling unit (EDU) would be needed to generate the pro rata share from new development. However, such impact fee increases may be challenged on the basis of their onerous burden or duplication of park fees. Despite the challenge, this source of revenues could provide a significant amount of resources to help implement a portion of the trail system.

6. Park and Open Space District

A possible future ballot measure considers the formation of an assessment district for San Bernardino County to fund, among other things, trail development. This measure would generate between \$170-544,000 annually to the city for trail, park and open space acquisition and development. Additional capital items may also be funded by the district when the revenue allocation formula is finally established. This measure still requires further refinement and, of course, voter approval.

These six funding mechanisms constitute the principal sources to generate revenues. Only the assessment districts offer any really sizable, reliable and available sources of revenue. All of the other revenue and non-revenue financing sources provide important but limited, irregular and uncertain mechanisms. Any financing plan able to achieve even partial trail improvements will need reliable sources of long term funding.

A summary of the available financing sources are presented on Table 5. It can be observed that there are financing mechanisms able to provide all of the needed revenues to implement and maintain the proposed trail system. However, it must be noted that all of the means to secure ample and reliable sources of revenue would require a vote of the residents. Without strong community support, however, the chances of securing these sources are small. Without local voter approval the only reliable sources of trail funding appears to be the Article 3 grant and the development impact fee. With passage of the proposed Park and Open Space District, a significant new source of revenues would be established.

C. TRAIL FINANCING STRATEGY

The preceding discussion reveals that the trail system will require about \$75,000,000 in capital costs and about \$352,000 annually for maintenance and management costs. Furthermore, the discussion indicated that there are many financing sources, but that these sources are limited and unreliable. Under these circumstances the trail financing strategy must seek to optimize the greatest amount of trail implementation from the limited available financing sources.

In order to link trail implementation with financing sources it is necessary to list the objectives from which strategic choices can be made and measured. The financing strategy should seek to:

1. Utilize all available forms of financing sources;
2. Implement improvements sooner than later;
3. Provide the greatest amount of trail benefits;
4. Increase the reliability of the financing sources.
5. Rely upon financing sources that equitably distribute the costs.

Based upon a review of funding needs in relation to available financing sources, the following findings were formulated to describe the elements of a financing strategy.

1. No New Funding Sources

Without voter approval, there appear to be no new reliable funding sources to implement the trail system. Only the Article 3 grants appear to offer a reasonable chance of generating up to \$500,000 in capital revenues over the long term period. Thus, without effort and community support, there appears to be no new sources of funding.

2. Need to Prioritize Improvements

It is apparent that without strong community support very few segments of the trail system may be implemented. Efforts to prioritize implementation of trail segments should stress low capital cost improvements since high cost capital items, such as the street undercrossings, will not find sufficient funding.

3. Move to Secure Funding

Efforts should be directed toward the establishment of secure financing sources such as assessment districts and/or developer impact fees.

a) Consolidation of Existing Districts

Efforts should be directed toward incorporating trail maintenance costs into the consolidation actions of the current lighting and landscaping assessment districts. These trail maintenance costs are nominal at this time and should present little resistance as part of the consolidation.

b) Support for POSD Vote

A major new trail funding source could be secured with passage of the Park and Open Space District ballot measure. Active effort would be well directed toward formulating a measure which allocates a greater local share of the revenues to the city and generating community support for voter approval.

c) Establish a Trail Development Fee

A specific development fee may be created to cover trail implementation (as separate from parks). Such a fee must clearly establish the trail costs which can be considered the pro rata obligation of new development.

4. Prepare Application for Article 3 Grants

A limited amount of capital improvements may be initiated soon with award of an Article 3 grant. However, this initial capital expenditure will not likely exceed \$100,000. In addition, identify trail segments which may qualify as "commuter" facilities would be helpful in seeking state trail improvement grants.

5. Land Acquisitions Needs Non-Monetary Approach

There are not sufficient amounts of available funding to finance the \$1,360,000 needed to acquire the land or easements for the H/E trails. Any available revenues to acquire this land will only further limit the amount of trails which may be improved. Consequently, it will be necessary to devise a legal means by which the needed land or easements can be transferred to the city in return for trail maintenance services or property tax credits.

6. Little Need to Finance Maintenance Now

There is little need to increased levels of trail maintenance at this time since there appears to be little chance of expanding to Class I bikeways and H/E trails. The available funding for the trail system expansion will likely permit only low maintenance service cost trails like Class II and III bikeway segments to be implemented in the near future.

Based upon the preceding evaluation, we can offer the following specific recommendations to fund the trail system proposed in the draft TIP.

1. It does not appear that there are reasonably available sources of revenues to finance implementation of the entire trail system. Consequently, we would recommend that the trail system be implemented on a segment by segment basis as the funds become available. This suggests that:
 - a) the city initially prepare applications for Article 3 funds, and
 - b) support passage of the POSD ballot measure.
2. Action can be taken by the city to establish new future revenue sources. We recommend the following actions in this regard:
 - a) Undertake to establish a nexus relationship for the citywide bikeway and regional H/E trails in order to quantify, adopt and apply a trail development impact fee.
 - b) Promote the consolidation of the existing landscaping and lighting districts as a means to include bikeway maintenance responsibilities as part of the consolidated district.
 - c) Explore the degree of community support in order to determine the likelihood that some or all improvement and maintenance costs may be funded through a newly created trail assessment district citywide.
3. A trail coordinator position should be established and initially funded by the city in order to promote and advocate trail development. Specifically, the trail coordinator should:
 - a) Coordinate all trail planning and implementation activities.
 - b) Prepare Article 3 bikeway funding applications.
 - c) Promote adoption of the POSD ballot measure.
 - d) Undertake establishing a trail development impact fee.
 - e) Promote community support for special trail assessment district(s).

These recommended actions constitute the most effective way to initiate the process needed to secure trail funding to finance trail development in Rancho Cucamonga.

Table 1

TRAIL DEVELOPMENT COSTS

Trail System Component	Total Development Costs	Land Acquisition Costs	Construction Costs	
			Hard Costs ¹	Soft Costs ²
Bikeway Trails				
Class I	\$37,642,507	\$0	\$26,508,808	\$11,133,699
Class II	\$267,017	\$0	\$188,040	\$78,977
Class III	\$82,672	\$0	\$58,220	\$24,452
Subtotal Bikeways	\$37,992,196	\$0	\$26,755,068	\$11,237,128
Hiking & Equestrian Trails				
Regional Multi Purpose	\$13,738,983	\$0	\$9,675,340	\$4,063,643
Community	\$23,479,473	\$633,000	\$15,901,840	\$6,944,633
Subtotal H/E Trails	\$37,218,456	\$633,000	\$25,577,180	\$11,008,276
Total - All Trails	\$75,210,652	\$633,000	\$52,332,248	\$22,245,404

- Notes:
1. Hard costs cover all materials and labor to construct the facility.
 2. Soft costs cover construction supporting services including administration, design and inspections.

Source: Summary of Trails Constructions Costs (3/19/91)
AGAJANIAN & Associates

Table 2

ANNUAL TRAIL MAINTENANCE AND MANAGEMENT COSTS ¹

Item	Length (Miles)	Cost	Function
Bikeway Trails			
Class I	34.5	\$220,878 ^{2,7}	Maintenance
Class II	27.0	Nominal ³	Maintenance
Class III	25.8	Nominal ³	Maintenance
Subtotal Bikeways	87.3	\$220,878	
Hiking & Equestrian Trails			
Regional Multi-Purpose	34.0	\$86,156 ⁴	Maintenance
Community	63.0	\$106,407 ⁵	Maintenance
Subtotal H/E Trails	97.0	\$192,563	
Trail Coordinator		\$118,207 ⁶	Management
Total Recurring Costs		\$531,648	

1. Based upon development of entire trail system, excluding landscape maintenance.
2. Based upon \$2,816/mile maintenance cost, \$108/mile sweeping cost (12 per year), and \$120,000 for maintaining undercrossings.
3. Maintenance and sweeping provided by budgeted street maintenance and sweeping operations.
4. Based on \$2,534/mile for spraying/cleaning 6 times per year.
5. Based on \$1,689/mile for spraying/cleaning 6 times per year.
6. Assumes full time associate level planner with \$43,116 annual salary and 35% benefits and a full time maintenance supervisor position at \$60,000 per year.
7. A new sweeper and pickup will be required at an estimated cost of \$75,000. This is a one time capital cost which has been excluded from these annualized maintenance costs.

Source: AGAJANIAN & Associates

Table 3

CHARACTERISTICS OF POTENTIAL FINANCING MECHANISMS

Funding Sources	Potential Financial Mechanism	Type of Resource	Frequency of Receipts	Trail System Applicability*	Payers	Relative Operating Costs
1. City General Fund	Property Tax	Monetary	Annual	M/A/I/T	Property Owners	Low
	Sales Tax	Monetary	Annual	M/A/I/T	Shoppers	Low
	Property Transfer Tax	Monetary	Annual	M/A/I/T	Property Sellers	Low
2. City User Fees	Bicycle Licenses	Monetary	Annual	M/I/T	Bicycle Owners	Low
	Horse Licenses	Monetary	Annual	M/I/T	Horse Owners	Moderate
	Concessions	Monetary	Annual	M/I/T	Volunteers	Moderate
3. City Special Funds	State Roadway Funds	Monetary	Annual	A/I/T	Gas Purchasers	Low
	CDBG	Monetary	One-Time	M/A/I/T	U.S. Taxpayers	Moderate
	Redevelopment	Monetary	Either/Both	A/I	Property Owners	Moderate
4. Assessment Districts	Special Assessment	Monetary	One-Time	A/I	District Property Owners	High
	Benefit Assessment	Monetary	Annual	M/T	District Property Owners	High
	Mello-Roos	Monetary	One-Time	A/I	District Property Owners	High
5. Volunteer Donations	Donations	Both	Either/Both	A/I	Individuals	Moderate
	Trusts/Endowments	Both	Both	A/I	Individuals	High
	Improvement Groups	In-Kind	Either/Both	M	User Groups	High
6. Regulation	Development Fees	Both	One-Time	A/I	New Development	Moderate
	Dedications	In-Kind	One-Time	A	New Development	Moderate
	Entitlement Approvals	Both	One-Time	A/I	New Development	Moderate
7. Grants	State Grants	Monetary	One-Time	A/I	State Taxpayers	High
	Federal Grants	Monetary	One-Time	A/I	U.S. Taxpayers	High
	Joint Use of R-O-W	In-Kind	Annual	A	R-O-W Owners	Moderate

* M = Management A = Acquisition I = Improvement T = Maintenance

Source: AGAJANIAN & Associates

Table 4

OPPORTUNITIES AND CONSTRAINTS OF TRAIL FUNDING SOURCES

Funding Sources	Opportunities	Constraints
1. City General Fund	<ul style="list-style-type: none"> • May be applied to all aspects of trail financing • May link trail financing to a specific tax 	<ul style="list-style-type: none"> • General Fund is limited in size • Trails must compete with other higher priority budget needs • Annual budget process makes future funding uncertain
2. City User Fees	<ul style="list-style-type: none"> • Allocates costs directly to users • Can be applied to all aspects of trail financing • Does not require ballot approval 	<ul style="list-style-type: none"> • Limited amount of revenues can be generated • Annual funding is unreliable • Administrative cost high relative to receipts
3. City Special Funds	<ul style="list-style-type: none"> • Roadway fund may be applied to trail improvements and maintenance • Redevelopment funds may be used in developed areas of the city 	<ul style="list-style-type: none"> • Trails must compete with other high priority needs • Annual budget process makes future funding uncertain
4. Assessment Districts	<ul style="list-style-type: none"> • May be used to generate large sums for trail acquisition and improvements • May be used to generate annual revenues for management and maintenance. • Opportunity to consolidate with existing districts • District area may be less than entire city 	<ul style="list-style-type: none"> • Ballot approval required for all districts • High cost for establishing district • Public approval difficult to obtain without specific and highly needed improvements
5. Volunteer/Donations	<ul style="list-style-type: none"> • Any resources received are beneficial since they are gifts • Dedications of land or easements can help reduce acquisition costs substantially 	<ul style="list-style-type: none"> • Highly unreliable source of funding in amount and timing • In-kind gifts may not be applicable to trail needs • In-kind gifts may need to be converted into cash
6. Regulation	<ul style="list-style-type: none"> • Can produce trail acquisition and improvement at no direct cost to city • Can create options to negotiate for direct/indirect benefits 	<ul style="list-style-type: none"> • Are least applicable to already developed areas where need is greatest • Varying pace of development creates uncertainty for future assistance
7. Grants	<ul style="list-style-type: none"> • Many sources of grants are available for trail management, acquisition and improvement • Can generate large one-time revenues for development of specific trail segments • Can utilize corridors used for other purposes 	<ul style="list-style-type: none"> • Are highly competitive, requiring documented need and urgency • Award for grants unpredictable • Requires staff effort to prepare applications • May require local matching funds

Source: AGAJANIAN & Associates

Table 5

AVAILABLE TRAIL FINANCING SOURCES

Rancho Cucamonga

Financing Source	Estimated Amount	Use
Property Transfer Tax*	\$85,000/yr	Capital Operating
Retail Sales Tax*	\$508,000/yr	Capital Operating
Artical 3 Grant	\$250-500,000	Capital
User Fees	Unknown	Capital
Assessment District*	As approved by voters	Capital Operating
Development Impact Fees	\$2-3,000,000/yr	Capital
Parks/OS District*	\$170-544,000/yr \$7,312,000	Operating Capital

* Require voter approval

Source: AGAJANIAN & Associates

9.3 TRAIL STANDARD DRAWINGS

The standard drawings will be distributed under separate cover for insertion here.

9.4 ORDINANCE - TRAIL MAINTENANCE

AN ORDINANCE OF THE CITY COUNCIL OF THE CITY OF RANCHO CUCAMONGA, CALIFORNIA, APPROVING DEVELOPMENT CODE AMENDMENT NO. 88-08, AMENDING TITLE 17, SECTION 17.08.070 OF THE RANCHO CUCAMONGA MUNICIPAL CODE, ESTABLISHING TRAIL MAINTENANCE STANDARDS.

The City Council of the City of Rancho Cucamonga, California, does ordain as follows:

SECTION 1: Subsection E is added to Section 17.08.070 of Chapter 17.08 to read as follows:

- E. Local Feeder Trail Maintenance. All local feeder trails shall be maintained by the property owner in a safe and passable manner which does not detract from the use or appearance of the trail, and in a manner consistent with the following standards:
1. Scrap lumber, junk, trash, storage, or debris are prohibited.
 2. Abandoned, discarded or unused objects or equipment, such as automobiles, automotive parts, furniture, stoves, refrigerators, cans, containers, or similar items are prohibited.
 3. Trail surface and proper grade shall be continuously maintained for safety and rideability, including removal of excessive size rocks, filling pot holes, weed removal, and refilling ruts caused by erosion or other disturbances of the trail surface with new surfacing material per City standards.
 4. Construction of any structure within or across the trail easement, including walls and fences, gates, planters, sidewalk, drive approach or similar structures, or installation of any vegetation or irrigation system or device or obstacle of any kind is prohibited.
 5. Vegetation, except heritage trees as defined by Municipal Code Section 19.08.030, shall be kept cleared from encroaching into the trail to a height of ten (10) feet and to the full width of the trail.
 6. Trail fences and gates shall be kept in good repair at all times, including replacing damaged members, and maintaining plumb. This shall not preclude the property owner from replacing the existing trail fence with another fence or wall material.
 7. Drainage swales, curb and gutter, or similar drainage structures, shall be kept clean and free of debris, trash, soil, vegetation, or other material in a manner that permits proper drainage.

SECTION 2: This Council finds that this amendment will not adversely effect the environment and hereby issues a Negative Declaration.

The Mayor shall sign this Ordinance and the City Clerk shall cause the same to be published within fifteen (15) days after its passage at least once in The Daily Report, a newspaper of general circulation published in the City of Ontario, California, and circulated in the City of Rancho Cucamonga.

PASSED, APPROVED, AND ADOPTED this _____ day of _____, 1990.

9.5 ORDINANCE - BICYCLE STORAGE FACILITIES

AN ORDINANCE OF THE CITY COUNCIL OF THE CITY OF RANCHO CUCAMONGA, CALIFORNIA, APPROVING DEVELOPMENT CODE AMENDMENT NO. _____, AMENDING TITLE 17, SECTION 17.12.040.C.4 OF THE RANCHO CUCAMONGA MUNICIPAL CODE, REGARDING BICYCLE STORAGE FACILITIES.

The City Council of the City of Rancho Cucamonga, California, does ordain as follows:

SECTION 1: Section 17.12.040.C.4. is amended to read as follows:

4. Bicycle Storage: Bicycle storage spaces shall be provided in all commercial, office, and industrial districts in accordance with the following:

(a) Minimum spaces equal to five (5) percent of the required automobile parking spaces or two (2) bicycle storage spaces, whichever is greater. After the first fifty (50) bicycle storage spaces are provided, additional storage spaces required are two and one-half (2.5) percent of the required automobile parking spaces. Warehouse distribution uses shall provide bicycle storage spaces at a rate of two and one-half (2.5) percent of the required automobile parking spaces. In no case shall the total number of bicycle parking spaces required exceed 100. Where this results in a fraction of 0.5 or greater, the number shall be rounded off to the higher whole number.

(b) The bicycle storage spaces shall be located a maximum of two times the distance between main building entrances and the nearest parking spaces to those entrances.

(c) The bicycle storage spaces shall be a minimum length of six feet, a minimum width of two feet, with a minimum overhead clearance of six feet.

(d) An aisle or other space shall be provided for bicycles to enter and leave the storage spaces. This aisle shall have width of at least five feet to the front or the rear of a standard six-foot bicycle parked in the space.

(e) Security racks shall be provided for each storage space, and should be located in highly visible areas to minimize theft and vandalism.

(f) Office or industrial projects with over 100 automobile spaces shall provide all-weather storage lockers for fifty (50) percent of the required bicycle storage spaces. A "locker" is defined as a fully-enclosed space accessible only to the owner or operator of the bicycle. This space may also serve other purposes. A locked room or locked enclosure accessible only to the owners or operators of bicycles parked within may qualify.

(g) The following uses shall be exempt:

1. Temporary uses per Section 17.04.070.
2. Drive-in businesses, including theaters (other than fast food restaurants).
3. Hotels and motels.
4. Kiosks for key shops, film drops, etc.
5. Mini-storage facilities.
6. Recreational vehicle storage yard.
7. Vehicular storage yard and towing service.
8. Scrap yard.
9. Caretakers residence.
10. Other uses as determined by the City Planner.

From

... ..
... ..
... ..

... ..

... ..

... ..

AN ORDINANCE OF THE CITY COUNCIL OF THE CITY OF
RANCHO CUCAMONGA, CALIFORNIA, APPROVING
INDUSTRIAL AREA SPECIFIC PLAN AMENDMENT NO. 90-03
AMENDING PART III, SECTION IV.F REGARDING
BICYCLE STORAGE FACILITIES.

The City Council of the City of Rancho Cucamonga, California, does hereby ordain as follows:

SECTION 1: Part III, Section IV.F.4. is amended to read as follows:

F.4. Bicycle storage facilities shall be provided within all development, and relate to planned and existing bicycle trails, in accordance with the Development Code requirements.

SECTION 2: Part III, Section IV.F.5. is amended to read as follows:

F.5. For developments with at least 40 total parking spaces, required on-site parking may be reduced at a rate of one automobile parking space per 4 spaces of bicycle storage, up to 50 automobile parking spaces or 10% of total required on-site parking, whichever is less, where locker rooms and showers are provided for employees to promote bicycle commuting.

SECTION 3: This Council finds that this amendment will not adversely effect the environment and hereby issues a Negative Declaration.

The Mayor shall sign this Ordinance and the City Clerk shall cause the same to be published within fifteen (15) days after its passage at least once in the Daily Report, a newspaper of general circulation published in the City of Ontario, California, and circulated in the City of Rancho Cucamonga.

PASSED, APPROVED, and ADOPTED this _____ day of _____, 1990.

1. The first part of the document discusses the importance of maintaining accurate records of all transactions. It emphasizes that this is crucial for the company's financial health and for providing reliable information to stakeholders.

2. The second part of the document outlines the specific procedures for recording transactions. It details the steps from identifying a transaction to entering it into the accounting system, ensuring that all necessary details are captured.

3. The third part of the document addresses the role of the accounting department in monitoring and controlling the company's resources. It discusses how accurate records enable the company to identify areas of inefficiency and to take corrective action.

4. The fourth part of the document discusses the importance of internal controls in preventing fraud and errors. It highlights the need for a strong system of checks and balances to ensure the integrity of the financial data.

5. The fifth part of the document discusses the role of the accounting department in providing financial information to management. It explains how this information is used to make strategic decisions and to evaluate the company's performance.

6. The sixth part of the document discusses the importance of transparency and communication in the financial reporting process. It emphasizes the need for clear and concise reporting to ensure that all stakeholders have a clear understanding of the company's financial position.

7. The seventh part of the document discusses the role of the accounting department in ensuring compliance with applicable laws and regulations. It highlights the importance of staying up-to-date on changes in the regulatory environment.

8. The eighth part of the document discusses the importance of the accounting department in supporting the company's growth and expansion. It explains how accurate financial data is essential for identifying new opportunities and for managing risk.

9. The ninth part of the document discusses the role of the accounting department in providing financial information to investors and other external stakeholders. It emphasizes the need for high-quality, reliable information to build trust and confidence.

10. The tenth part of the document discusses the importance of the accounting department in providing financial information to the public. It explains how this information is used to make informed decisions about the company and its future prospects.

11. The eleventh part of the document discusses the role of the accounting department in providing financial information to the government. It highlights the importance of accurate reporting to ensure the integrity of the financial system.

12. The twelfth part of the document discusses the importance of the accounting department in providing financial information to the media. It explains how this information is used to inform the public and to shape the company's public image.

13. The thirteenth part of the document discusses the role of the accounting department in providing financial information to the industry. It highlights the importance of accurate reporting to ensure the integrity of the industry's financial data.

9.6 TRAILS COORDINATOR JOB DESCRIPTION

TRAILS COORDINATOR

DEFINITION

Under the general supervision, coordinates all efforts in locating, acquisition and development of the Community and Regional Trails System as defined in the General Plan and Trails Implementation Plan; coordinates these issues with developer's, other city departments, and other public agencies; performs complex land negotiations; performs related duties as required.

PRINCIPAL DUTIES AND RESPONSIBILITIES

Duties may include, but are not limited to, the following:

1. Directs and coordinates the trail implementation program; seeks state or federal grant money for trail projects.
 2. Under direction, recommends priorities for acquisition of rights-of-way for Community Trails or acquisition of trail use rights for Regional Trails; assists in negotiations, with both public agencies and private property owners, for rights-of-way by lease, license, purchase and/or dedication through subdivision.
 3. Coordinates City and regional trail plans, initiates and encourages joint agency trail projects, reviews and comments on regional trail plans which may affect City trails, and represents City with other agencies on regional trail matters.
 4. Works with trail user groups and citizen advisory groups to insure their participation in route planning and design; serves as the primary contact for communication of trail comments and problem identification; and promotes public education about, and use of, trails.
 5. Coordinates with various City departments; develops policies supplementary to the Trails Implementation Plan to aid in the development of the trails system; reviews and recommends construction standards for trails; reviews trail improvement construction plans for conformity with City standards.
 6. Will be responsible for proposed trail alignments for consideration in preparation of acquisition evaluation and capital improvement plans.
 7. Prepares and presents reports before the City Council, Planning Commission, Parks and Recreation Commission, and Trails Advisory Committee concerning trail matters.
 8. Assists in the preparation of budget for trail projects; prepares and administers professional service contracts with outside consultants or contractors.
 9. Reviews and recommends maintenance standards for trails.
-

QUALIFICATIONS GUIDELINES

Education and/or Experience

Any combination of education and/or experience that has provided the knowledge, skills, and abilities necessary for satisfactory job performance. Example combinations include a bachelor's degree in public administration, recreation, landscape architecture, transportation planning, urban planning or a related field and three years of increasingly responsible professional experience in trail planning, property acquisition or grantsmanship.

Knowledge, Skills, and Abilities

Considerable knowledge of the principles and practices of trail planning, design and use. Working knowledge of law as it applies to property acquisition, trail improvement, and trail use. Considerable knowledge of the methods of acquiring trail rights-of-way and funding trail improvement projects. Ability to prepare complex grant proposals; deal effectively and negotiate with developers, property owners, and the general public; set priorities, and monitor work progress; interpret and apply provisions of codes, regulations, statutes, and ordinances relevant to trail activities; and make verbal and written presentations to individuals and groups; work cooperatively with others; analyze issues and draw logical, supportable conclusions.
